

# Fluid System Products

Fittings, Valves & Tubing  
Catalog





# Table of contents

## Company

RWC and John Guest™ Brands .....	4
Markets and applications .....	7
Standards and affiliations .....	9

## Fluid System Products

How to make a Push-Fit connection .....	11
Fittings .....	12
Valves .....	39
Accessories .....	45
LLDPE Tubing .....	47
Half Cartridges .....	49
Service and Repair Kits / Water Supply Kits .....	54
Single-Packed: OD Fittings & Valves .....	56

## JG ProLock™

How to make a ProLock connection .....	61
ProLock Fittings (Black CTS) .....	62
Flexi Hose .....	64
ProLock Fittings (Brass CTS) .....	65

## Twist & Lock™

How to make a Twist & Lock connection .....	67
Twist & Lock Fittings (White CTS) .....	68
Twist & Lock Fittings (Black CTS) .....	71
Single Packed: CTS Fittings and Valves .....	72
SharkBite™ PEX Pipe .....	74
Accessories (CTS) .....	75

## Appendix

Technical specifications .....	76
Terms and conditions .....	79
Warranty .....	80

# A valued member of the RWC family of brands

Our family of brands transform performance and efficiency for plumbing and heating, smart homes and specialist industries around the world. As a global family of powerful brands, we develop solutions that help our customers deliver, control, optimize and solve in innovative, reliable and simple ways every single day.

**John Guest™ is just one of RWC's world-class family of brands.**

As part of the RWC family, we continue to be a world-leading manufacturer of push-fit fittings, tubing and other fluid control products.

Since the launch of our company in the early 1960s, we continue to create inventive environments that encourage imaginative product design, making sure that we always lead, never follow.

Whether you're taking a shower, driving a car, making a call or even drinking a beer at the local bar, you could very well be interacting with one of our products. We offer innovative push-to-connect solutions for a diverse range of industries.

Today, millions of our push-to-connect fittings are manufactured and sold to a variety of specialist industries.

We continue to fulfill our heritage and solve even the most complex challenges. So thank you for giving us the opportunity to pioneer new products and transform the marketplace.

[johnguest.com](http://johnguest.com)



**At John Guest™ ,  
we're changing the  
way pipe and tube  
connections  
are made around  
the globe by  
transforming the  
movement of  
fluid, air and data.**



# Markets & applications



## Water Quality

Industry Segment: Industrial/Residential Water Treatment

Applications: Water Filters, Reverse Osmosis Systems, Whole House Softener Systems, Filter Cartridges and Filter Heads



## Appliance/OEM

Industry Segment: Refrigerator and Ice Water Systems

Applications: Automatic Ice Makers and Water Dispensing



## Agricultural

Industry Segment: Ag/Hydroponics and Aquaponics Equipment Manufacturers

Applications: Sprayers, Nozzles, Valves, Manifolds, Pumps, Hydroponics and Aquaponics Farming Equipment



## Car Washing

Industry Segment: Car Washing Equipment

Applications: Reverse Osmosis Systems, Iron Remediation Systems, Water Softeners, Carbon Softeners, Flow Meters, Pressure Gauges, Nozzles, Sprayers, Manifolds and Pumps



## Beverage Dispensing/ Coffee Services

Industry Segment: Beverage Dispensing and Coffee Brewing Equipment

Applications: Countertop Style Machines: Water Supply Line and Water Filters. Vending Machines: Dispensing Systems



## Air & Pneumatics Technology

Industry Segment: Compressed Air Systems

Applications: Air Filters/Regulators, Manifolds and Pneumatic Control Valves, Air Ring Mains and Air Line Service Components



## Marine/R.V.

Industry Segment: Industrial/Residential Water Treatment

Applications: Hot and Cold Water Distribution Systems and Potable Water Distribution Systems



## Health and Sanitization

Industry Segment: Health and Sanitization

Applications: Dental Equipment, Medical Lasers, Hot & Cold Therapy Systems, Dialysis Equipment, Pharmaceutical Equipment, Sanitizing Foggers/Misters, Hand Wash Stations, Portable Hand Sanitizer Stations

**By exceeding  
industry standards,  
our products  
uphold the  
utmost quality.**

**At John Guest™,  
we're not just a  
brand; we're a  
standard.**





# Standards & affiliations

Our fittings and related products are specifically designed and manufactured to adhere to the technical specifications set out in our John Guest™ product catalogs. All of our fittings and related products should be selected, installed, used and maintained in accordance with these technical specifications.



Ranges including the PP, PI, CI, SI, ASVPP, PASV, PPSV, PISV & LLDPE Tubing comply with NSF 51 and 61 International Standard Certifications for Drinking Water System Components and Materials that contact drinking water, including Annex G where applicable.

The PEI and PSEI Ranges of CTS fittings have NSF/ANSI Standard 14, which demonstrates compliance with USA Plumbing Codes, cNSFus – also in compliance with Canada and US Standards, CSA – Canadian Standards, PW – potable water. All have NSF Standard 61 Certification for drinking water system components and materials that contact drinking water, including Annex G where applicable.



The PEI and PSEI Ranges of CTS fittings comply with the applicable sections of the latest edition of the Uniform Plumbing Code® and the International Plumbing Code®, including behind-the-wall installations. Refer to the applicable code listings for the latest information applications.



The PEI and PSEI Ranges of CTS fittings are manufactured in compliance with ASTM F877, CSA B137.5 and ASSE 1061.



NSF standard 51 listed fittings in this brochure are produced in Food and Drug Administration (FDA) compliant materials and are, therefore, recommended for food quality applications.



John Guest quality systems are certified by BSI to BS EN ISO 9001.



Standard Push-Fit Fittings, Shut-Off Valves and Polyethylene Tubing are produced from FDA compliant materials.



John Guest products are produced from lead-free materials.

# Fluid System Products

## The push-fit people

Our push-fit fittings, shut-off valves and polyethylene tubing have been designed for use with a wide range of industrial water treatment applications, involving water purification, reverse osmosis, ice makers, beverage dispensing, vending & OCS, car washing systems, Marine/R. V. and many more.

Our fluid system products are simple to use without the need for special tools. This is just one of many reasons we are known for our innovative solutions across diverse industries.

Standard push-fit fittings, shut-off valves and polyethylene tubing are produced from FDA compliant materials and are listed with NSF International Standards 51 and 61.



# How to make a Push-Fit connection

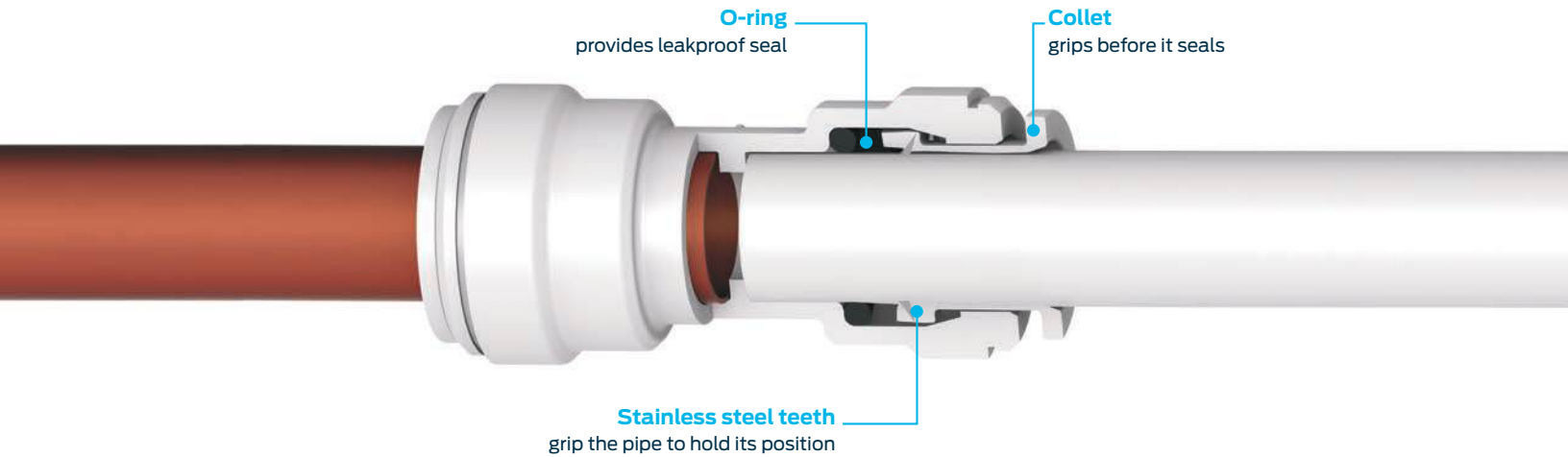

## To connect

Keep product clean until ready to use. Always pressure test once installed.



### Step 1

Cut the tube square and remove any burrs or score marks. We recommend using a tube insert for soft or thin-walled plastic tubing.



### Step 2

Push the tube into the fitting and up to the tube stop.



### Step 3

Pull on the tube to check that it is secure. Test the system before use.

## To disconnect



### Step 1

Make sure that the system is depressurized, then push the collet square against the fitting. With the collet held in this position, the tube can be removed.

# Fluid System Fittings

## Inch Polypropylene White

The PP Range of inch-size push-fit fittings is offered for tube sizes 1/4" OD to 1/2" OD. These fittings are manufactured in white polypropylene with food grade EPDM O-rings. They have been developed to satisfy the filtered pure water market and a wide range of applications.

**NOT suitable for compressed air applications. For these situations, we recommend the PI Range on pages 19 - 26.**

### Working pressures and temperatures

Water Max. 150 psi (10 bar) at 70 °F (20 °C)  
 Max. 60 psi (4 bar) at 140 °F (60 °C)  
 Min 33 °F / 1 °C



NSF 51  
NSF 61

For general technical specifications, refer to page 76.

### Male Connector NPTF Thread



Part Number	Tube OD	Thread NPTF	Bag Qty	Box Qty
PP010821W-US	1/4"	1/8"	10	500
PP010822W-US	1/4"	1/4"	10	400
PP010823W-US	1/4"	3/8"	10	400
PP010824W-US	1/4"	1/2"	10	200
PP011222W-US	3/8"	1/4"	10	250
PP011223W-US	3/8"	3/8"	10	250
PP011224W-US	3/8"	1/2"	10	250
PP011623W-US	1/2"	3/8"	10	150
PP011624W-US	1/2"	1/2"	10	150

### Union Tee



Part Number	Tube OD	Bag Qty	Box Qty
PP0208W-US	1/4"	10	300
PPM0208W	5/16"	10	200
PP0212W-US	3/8"	10	100
PP0216W-US	1/2"	10	80

### Union Elbow



Part Number	Tube OD	Bag Qty	Box Qty
PP0308W-US	1/4"	10	400
PPM0308W-US	5/16"	10	300
PP0312W-US	3/8"	10	200
PP0316W-US	1/2"	10	100

### Union Connector



Part Number	Tube OD	Bag Qty	Box Qty
PP0408W-US	1/4"	10	400
PPM0408W-US	5/16"	10	300
PP0412W-US	3/8"	10	200
PP0416W-US	1/2"	10	100

### Stem Adapter NPTF Thread



Part Number	Stem OD	Thread NPTF	Bag Qty	Box Qty
PP050821W-US	1/4"	1/8"	10	500
PP050822W-US	1/4"	1/4"	10	500
PP051222W-US	3/8"	1/4"	10	300
PP051223W-US	3/8"	3/8"	10	200
PP051623W-US	1/2"	3/8"	10	250
PP051624W-US	1/2"	1/2"	10	200

### Reducer



Part Number	Stem OD	Tube OD	Bag Qty	Box Qty
PP061208W-US	3/8"	1/4"	10	400
PP061210W-US	3/8"	5/16"	10	400
PP061612W-US	1/2"	3/8"	10	200
PP062008W-US	5/8"	1/4"	10	200
PP062012W-US	5/8"	3/8"	10	200
PP062016W-US	5/8"	1/2"	10	150

# Fluid Systems Fittings

## Inch Polypropylene White

### Plug



Part Number	Tube OD	Bag Qty	Box Qty
PP0808W-US	1/4"	10	500
PPM0808W-US	5/16"	10	500
PP0812W-US	3/8"	10	400
PP0816W-US	1/2"	10	300

### Swivel Male Elbow

NPTF Thread



Part Number	Tube OD	Thread NPTF	Bag Qty	Box Qty
PP090821W	1/4"	1/8"	10	300
PP090822W	1/4"	1/4"	10	200
PP091222W	3/8"	1/4"	10	100
PP091223W	3/8"	3/8"	10	100

### Swivel Male Branch Tee

NPTF Thread



Part Number	Tube OD	Thread NPTF	Bag Qty	Box Qty
PP100821W	1/4"	1/8"	10	200
PP100822W	1/4"	1/4"	10	200
PP101222W	3/8"	1/4"	10	100
PP101223W	3/8"	3/8"	10	100

### Swivel Male Run Tee

NPTF Thread



Part Number	Tube OD	Thread NPTF	Bag Qty	Box Qty
PP110822W	1/4"	1/4"	10	200
PP111222W	3/8"	1/4"	10	100
PP111223W	3/8"	3/8"	10	100

### Bulkhead Union



Part Number	Tube OD	Mounting Hole Dia.	Bag Qty	Box Qty
PP1208W-US	1/4"	0.67"	10	200
PP1212W-US	3/8"	0.83"	10	100
PP1216W-US	1/2"	1.06"	5	50

### Reducing Bulkhead Union



Part Number	Tube OD	Tube OD	Mounting Hole Dia.	Bag Qty	Box Qty
PP121208W-US	3/8"	1/4"	0.83"	10	150

PP Bulkhead Unions are not intended for submerged use.

PP Bulkhead Unions are not intended for submerged use.

### Reducing Union Connector



Part Number	Tube OD	Tube OD	Bag Qty	Box Qty
PP201208W-US	3/8"	1/4"	10	250
PP201612W-US	1/2"	3/8"	10	150

### Reducing Elbow



Part Number	Tube OD	Tube OD	Bag Qty	Box Qty
PP211008W-US	5/16"	1/4"	10	300
PP211208W-US	3/8"	1/4"	10	200
PP211612W-US	1/2"	3/8"	10	150

### Plug In Elbow



Part Number	Stem OD	Tube OD	Bag Qty	Box Qty
PP220808W-US	1/4"	1/4"	10	500
PPM220808W-US	5/16"	5/16"	10	400
PP221208W-US	3/8"	1/4"	10	300
PP221212W-US	3/8"	3/8"	10	200
PP221616W-US	1/2"	1/2"	10	150

# Fluid Systems Fittings

## Inch Polypropylene White

### Two Way Divider



Part Number	Tube OD	Bag Qty	Box Qty
PP2312W-US	3/8"	10	150

### Reducing Two Way Divider



Part Number	Tube OD Inlet	Tube OD Outlet	Bag Qty	Box Qty
PP241208W-US	3/8"	1/4"	10	200

### Tube to Hose Stem



Part Number	Stem OD	Hose ID	Bag Qty	Box Qty
PP251212W-US	3/8"	3/8"	10	400
PP251216W-US	3/8"	1/2"	10	300
PP251612W-US	1/2"	3/8"	10	300
PP251616W-US	1/2"	1/2"	10	250

### Reducing Tee



Part Number	Tube OD	Tube OD	Tube OD Branch	Bag Qty	Box Qty
PP30080812W-US	1/4"	1/4"	3/8"	10	150
PP30120812W-US	3/8"	1/4"	3/8"	10	150
PP30121208W-US	3/8"	3/8"	1/4"	10	150
PP301612W-US	1/2"	1/2"	3/8"	10	50

### Faucet Connector UNS Thread



Part Number	Tube OD	Thread UNS	Bag Qty	Box Qty
PP3208U7W-US	1/4"	7/16"-24	10	400
PP3212U7W-US	3/8"	7/16"-24	10	300

7/16 – 24 UNS = 1/4 Compression Threads

### Female Adapter NPTF Thread



Part Number	Tube OD	Thread NPTF	Bag Qty	Box Qty
PP450821W-US	1/4"	1/8"	10	400
PP450822W-US	1/4"	1/4"	10	200
PP451222W-US	3/8"	1/4"	10	200
PP451223W-US	3/8"	3/8"	10	150

### End Cap



Part Number	Tube OD	Bag Qty	Box Qty
PP4608W-US	1/4"	10	500

### Fixed Elbow NPTF Thread



Part Number	Tube OD	Thread NPTF	Bag Qty	Box Qty
PP480821W-US	1/4"	1/8"	10	500
PP480822W-US	1/4"	1/4"	10	400
PP480823W-US	1/4"	3/8"	10	300
PP481222W-US	3/8"	1/4"	10	200
PP481223W-US	3/8"	3/8"	10	200
PP481623W-US	1/2"	3/8"	10	150

### Three Way Divider



Part Number	Tube OD Inlet	Tube OD Outlet	Bag Qty	Box Qty
PP491208W-US	3/8"	1/4"	10	150

# Fluid Systems Fittings

## Inch Polypropylene White

### Stackable Tee



Part Number	Tube OD Inlet	Stem OD	Tube OD Outlet	Bag Qty	Box Qty
PP531212W-US	3/8"	3/8"	3/8"	10	150

### Female Connector



Part Number	Tube OD	Thread UNEF	Bag Qty	Box Qty
PP6008U9W-US	1/4"	9/16"-24	10	300

9/16 - 24 UNEF = 3/8 Compression Threads

For 3/8" OD x 9/16" - 24 female connector see page 32

### Fixed Tee Adapter NPTF Thread



Part Number	Tube OD Ends	NPTF Branch	Bag Qty	Box Qty
PP641223W-US	3/8"	3/8"	10	150

# Fluid System Fittings

## Inch Polypropylene Black

The PP Range of inch-size push-fit fittings is offered for tube sizes 1/4" OD to 1/2" OD. These fittings are manufactured in black polypropylene with food grade EPDM O-rings. They have been developed to satisfy the needs of the Water Purification and Beverage Dispensing Markets. Black polypropylene fittings are UV stabilized and are ideal for use in Agricultural Spraying, Car Wash Chemical Dispense, Farm Machinery and Dairy Equipment applications.

**NOT suitable for compressed air applications. For these situations, we recommend the PI Range on pages 19 - 26.**

### Working pressures and temperatures

Water Max. 150 psi (10 bar) at 70°F (20°C)  
 Max. 60 psi (4 bar) at 140°F (60°C)  
 Min 33°F/1°C



NSF 51  
NSF 61

For general technical specifications, refer to page 76.

### Male Connector NPTF Thread



Part Number	Tube OD	Thread NPTF	Bag Qty	Box Qty
PP010821E-US	1/4"	1/8"	10	500
PP010822E-US	1/4"	1/4"	10	400
PP010823E-US	1/4"	3/8"	10	400
PP011222E-US	3/8"	1/4"	10	250
PP011223E-US	3/8"	3/8"	10	250
PP011224E-US	3/8"	1/2"	10	250

### Union Tee



Part Number	Tube OD	Bag Qty	Box Qty
PP0208E-US	1/4"	10	300
PPM0208E	5/16"	10	200
PP0212E-US	3/8"	10	100

### Union Elbow



Part Number	Tube OD	Bag Qty	Box Qty
PP0308E-US	1/4"	10	400
PP0312E-US	3/8"	10	200
PP0316E-US	1/2"	10	100

### Union Connector



Part Number	Tube OD	Bag Qty	Box Qty
PP0408E-US	1/4"	10	400
PPM0408E-US	5/16"	10	300
PP0412E-US	3/8"	10	200

### Stem Adapter NPTF Thread



Part Number	Stem OD	Thread NPTF	Bag Qty	Box Qty
PP050821E-US	1/4"	1/8"	10	500
PP050822E-US	1/4"	1/4"	10	500
PP051223E-US	3/8"	3/8"	10	200

### Reducer



Part Number	Stem OD	Tube OD	Bag Qty	Box Qty
PP062012E-US	5/8"	3/8"	10	200



# Fluid Systems Fittings

## Inch Polypropylene Black

### Plug



Part Number	Tube OD	Bag Qty	Box Qty
PP0812E-US	3/8"	10	400

### Bulkhead Union



Part Number	Tube OD	Mounting Hole Dia.	Bag Qty	Box Qty
PP1208E-US	1/4"	0.67"	10	200
PP1212E-US	3/8"	0.83"	10	100

Bulkhead Unions are not intended for submerged use.

### Reducing Union Connector



Part Number	Tube OD	Tube OD	Bag Qty	Box Qty
PP201208E-US	3/8"	1/4"	10	250
PP201612E-US	1/2"	3/8"	10	150

### Reducing Elbow

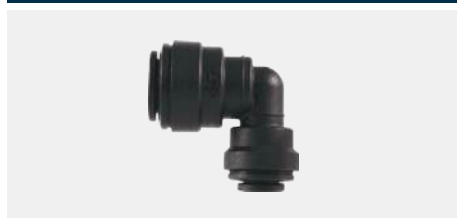

Part Number	Tube OD	Tube OD	Bag Qty	Box Qty
PP211208E-US	3/8"	1/4"	10	200

### Plug In Elbow

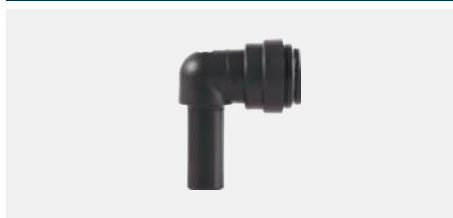

Part Number	Stem OD	Tube OD	Bag Qty	Box Qty
PP220808E-US	1/4"	1/4"	10	500
PP221208E-US	3/8"	1/4"	10	300
PP221212E-US	3/8"	3/8"	10	200
PP221616E-US	1/2"	1/2"	10	150

### Two Way Divider



Part Number	Tube OD	Bag Qty	Box Qty
PP2308E-US	1/4"	10	200

### Female Adapter NPTF Thread



Part Number	Tube OD	Thread NPTF	Bag Qty	Box Qty
PP450821E-US	1/4"	1/8"	10	400
PP450822E-US	1/4"	1/4"	10	200

### Fixed Elbow NPTF Thread



Part Number	Tube OD	Thread NPTF	Bag Qty	Box Qty
PP480821E-US	1/4"	1/8"	10	500
PP480822E-US	1/4"	1/4"	10	400
PP480823E-US	1/4"	3/8"	10	300
PP481222E-US	3/8"	1/4"	10	200
PP481223E-US	3/8"	3/8"	10	200

### Straight Shut-Off Valve Speedfit to Speedfit



Part Number	Tube OD	Bag Qty	Box Qty
PPSV040808E-US	1/4"	200	200
PPSV041212E-US	3/8"	80	80

# Fluid System Fittings

## Inch Acetal Gray

The PI Range of inch-size push-fit fittings is offered for tube sizes 5/32" OD to 1/2" OD. These fittings are manufactured in gray acetal copolymer with a food grade nitrile O-ring, making them especially suitable for applications involving foodstuffs and potable liquids. They are also suitable for air and inert gases and can, therefore, be used on CO<sub>2</sub> lines, pneumatic applications and vacuum.

### Working pressures and temperatures

5/32"-5/16": Max. 230 psi at 68°F  
 Max. 150 psi at 150°F

3/8"-1/2": Max. 150 psi at 68°F  
 Max. 100 psi at 150°F



NSF 51  
 NSF 61

For general technical specifications, refer to page 76.

### Male Connector NPTF Thread



Part Number	Tube OD	Thread NPTF	Bag Qty	Box Qty
PM010421S-US	5/32"	1/8"	10	500
PM010422S-US	5/32"	1/4"	10	500
PI010621S-US	3/16"	1/8"	10	500
PI010821S-US	1/4"	1/8"	10	500
PI010822S-US	1/4"	1/4"	10	400
PI010823S-US	1/4"	3/8"	10	300
PM010821S-US	5/16"	1/8"	10	400
PM010822S-US	5/16"	1/4"	10	400
PM010823S-US	5/16"	3/8"	10	300
PI011221S-US	3/8"	1/8"	10	250
PI011222S-US	3/8"	1/4"	10	250
PI011223S-US	3/8"	3/8"	10	250
PI011224S-US	3/8"	1/2"	10	200
PI011623S-US	1/2"	3/8"	10	150
PI011624S-US	1/2"	1/2"	10	150
PI012026S-US	5/8"	3/4"	10	100

### Male Connector BSPT Thread



Part Number	Tube OD	Thread BSPT	Bag Qty	Box Qty
PI010601S	3/16"	1/8"	10	500
PI010801S-US	1/4"	1/8"	10	500
PI010802S-US	1/4"	1/4"	10	400
PM010801S-US	5/16"	1/8"	10	400
PM010802S	5/16"	1/4"	10	400
PM010803S-US	5/16"	3/8"	10	300
PI011202S-US	3/8"	1/4"	10	250
PI011203S-US	3/8"	3/8"	10	250
PI011603S-US	1/2"	3/8"	10	150
PI011604S-US	1/2"	1/2"	10	150

### Male Connector BSPP Thread



Part Number	Tube OD	Thread BSPP	Bag Qty	Box Qty
PI010812S-US	1/4"	1/4"	10	250
PI011212S-US	3/8"	1/4"	10	250
PI011213S-US	3/8"	3/8"	10	250

# Fluid System Fittings Inch Acetal Gray

## Male Connector BSPB Thread



Part Number	Tube OD	Thread BSPB	Bag Qty	Box Qty
NCPI011211S-US	3/8"	1/8"	10	200
NCPI011212S-US	3/8"	1/4"	10	250

No thread seal on 3/8" x 1/8"  
3/8" x 1/4" has special large seal for use with chamfered face ports

## Male Connector MFL Thread - 45° Flare



Part Number	Tube OD	Thread MFL	Bag Qty	Box Qty
PI0108F4S-US	1/4"	1/4"	10	300
PI0112F4S-US	3/8"	1/4"	10	250
PI0112F5S-US	3/8"	5/16"	10	250
PI0112F6S-US	3/8"	3/8"	10	300
PI0116F8S	1/2"	1/2"	10	200

1/4" (MFL) corresponds to a 7/16-20 UNF  
5/16" (MFL) corresponds to a 1/2-20 UNF  
3/8" (MFL) corresponds to a 5/8-18 UNF  
1/2" (MFL) corresponds to a 3/4-16 UNF

## Union Tee



Part Number	Tube OD	Bag Qty	Box Qty
PM0204S-US	5/32"	10	400
PI0206S-US	3/16"	10	400
PI0208S-US	1/4"	10	300
PM0208S-US	5/16"	10	200
PI0212S-US	3/8"	10	100
PI0216S-US	1/2"	10	50

## Union Elbow



Part Number	Tube OD	Bag Qty	Box Qty
PM0304S-US	5/32"	10	500
PI0306S-US	3/16"	10	500
PI0308S-US	1/4"	10	400
PM0308S-US	5/16"	10	300
PI0312S-US	3/8"	10	200
PI0316S-US	1/2"	10	100

## Union Connector



Part Number	Tube OD	Bag Qty	Box Qty
PM0404S-US	5/32"	10	500
PI0406S-US	3/16"	10	500
PI0408S-US	1/4"	10	400
PM0408S-US	5/16"	10	300
PI0412S-US	3/8"	10	200
PI0416S-US	1/2"	10	100

## Stem Adapter NPTF Thread



Part Number	Stem OD	Thread NPTF	Bag Qty	Box Qty
PM050421S-US	5/32"	1/8"	10	500
PM050422S-US	5/32"	1/4"	10	500
PI050621S	3/16"	1/8"	10	500
PI050821S-US	1/4"	1/8"	10	500
PI050822S-US	1/4"	1/4"	10	500
PI050823S-US	1/4"	3/8"	10	300
PM050821S-US	5/16"	1/8"	10	500
PM050822S-US	5/16"	1/4"	10	500
PM050823S-US	5/16"	3/8"	10	300
PI051222S-US	3/8"	1/4"	10	300
PI051223S-US	3/8"	3/8"	10	300
PI051623S-US	1/2"	3/8"	10	150
PI051624S-US	1/2"	1/2"	10	150

# Fluid System Fittings

## Inch Acetal Gray

### Stem Adapter BSPT Thread



Part Number	Stem OD	Thread BSPT	Bag Qty	Box Qty
PI050601S	3/16"	1/8"	10	500
PI050801S-US	1/4"	1/8"	10	500
PI050802S-US	1/4"	1/4"	10	500
PM050801S-US	5/16"	1/8"	10	500
PM050802S	5/16"	1/4"	10	500
PM050803S	5/16"	3/8"	10	300
PI051202S	3/8"	1/4"	10	300
PI051203S-US	3/8"	3/8"	10	300
PI051603S-US	1/2"	3/8"	10	200
PI051604S-US	1/2"	1/2"	10	150

### Stem Adapter BSPP Thread



Part Number	Stem OD	Thread BSPP	Bag Qty	Box Qty
PM050812S	5/16"	1/4"	10	500
PI051212S-US	3/8"	1/4"	10	300
PI051213S-US	3/8"	3/8"	10	300

### Reducer



Part Number	Stem OD	Tube OD	Bag Qty	Box Qty
PI060605S-US	3/16"	5/32"	10	500
PI061006S-US	5/16"	3/16"	10	500
PI061008S-US	5/16"	1/4"	10	500
PI061206S-US	3/8"	3/16"	10	500
PI061208S-US	3/8"	1/4"	10	400
PI061210S-US	3/8"	5/16"	10	400
PI061610S-US	1/2"	5/16"	10	300
PI061612S-US	1/2"	3/8"	10	250

### Plug



Part Number	Tube OD	Bag Qty	Box Qty
PM0804S-US	5/32"	10	1000
PI0806S-US	3/16"	10	1000
PI0808S-US	1/4"	10	500
PM0808S-US	5/16"	10	500
PI0812S-US	3/8"	10	400
PI0816S-US	1/2"	10	300

### Swivel Male Elbow NPTF Thread



Part Number	Tube OD	Thread NPTF	Bag Qty	Box Qty
PM090421S-US	5/32"	1/8"	10	400
PM090422S	5/32"	1/4"	10	200
PI090621S-US	3/16"	1/8"	10	200
PI090821S-US	1/4"	1/8"	10	200
PI090822S-US	1/4"	1/4"	10	200
PM090821S	5/16"	1/8"	10	200
PM090822S-US	5/16"	1/4"	10	200
PM090823S-US	5/16"	3/8"	10	200
PI091221S	3/8"	1/8"	10	200
PI091222S-US	3/8"	1/4"	10	100
PI091223S-US	3/8"	3/8"	10	100
PI091622S	1/2"	1/4"	10	100
PI091623S-US	1/2"	3/8"	10	50
PI091624S-US	1/2"	1/2"	10	50

### Swivel Male Elbow BSPT Thread



Part Number	Tube OD	Thread BSPT	Bag Qty	Box Qty
PI090601S	3/16"	1/8"	10	200
PI090801S-US	1/4"	1/8"	10	200
PI090802S-US	1/4"	1/4"	10	200
PM090802S	5/16"	1/4"	10	200
PM090803S	5/16"	3/8"	10	200
PI091202S-US	3/8"	1/4"	10	100
PI091203S-US	3/8"	3/8"	10	100
PI091603S-US	1/2"	3/8"	10	50
PI091604S-US	1/2"	1/2"	10	50

# Fluid System Fittings Inch Acetal Gray

Swivel Male Branch Tee  
NPTF Thread



Part Number	Tube OD	Thread NPTF	Bag Qty	Box Qty
PM100421S-US	5/32"	1/8"	10	200
PI100621S	3/16"	1/8"	10	200
PI100821S-US	1/4"	1/8"	10	200
PI100822S-US	1/4"	1/4"	10	200
PM100821S-US	5/16"	1/8"	10	100
PM100822S-US	5/16"	1/4"	10	100
PM100823S	5/16"	3/8"	10	100
PI101222S-US	3/8"	1/4"	10	100
PI101223S-US	3/8"	3/8"	10	100
PI101623S-US	1/2"	3/8"	5	50
PI101624S-US	1/2"	1/2"	5	50

Swivel Male Branch Tee  
BSPT Thread



Part Number	Tube OD	Thread BSPT	Bag Qty	Box Qty
PI100801S	1/4"	1/8"	10	200
PI100802S	1/4"	1/4"	10	200
PM100803S	5/16"	3/8"	10	100
PI101202S	3/8"	1/4"	10	100
PI101203S	3/8"	3/8"	10	100
PI101603S	1/2"	3/8"	5	50
PI101604S-US	1/2"	1/2"	5	50

Swivel Male Run Tee  
NPTF Thread



Part Number	Tube OD	Thread NPTF	Bag Qty	Box Qty
PI110621S-US	3/16"	1/8"	10	200
PI110821S-US	1/4"	1/8"	10	200
PI110822S-US	1/4"	1/4"	10	200
PM110821S	5/16"	1/8"	10	100
PM110822S	5/16"	1/4"	10	100
PI111222S-US	3/8"	1/4"	10	100
PI111223S-US	3/8"	3/8"	10	100
PI111623S	1/2"	3/8"	10	50
PI111624S	1/2"	1/2"	10	50

Swivel Male Run Tee  
BSPT Thread



Part Number	Tube OD	Thread BSPT	Bag Qty	Box Qty
PI110801S	1/4"	1/8"	10	200
PI110802S	1/4"	1/4"	10	200
PM110802S	5/16"	1/4"	10	100
PI111202S	3/8"	1/4"	10	100
PI111203S	3/8"	3/8"	10	100
PI111604S	1/2"	1/2"	5	50

Bulkhead Union



Part Number	Tube OD	Mounting Hole Dia.	Bag Qty	Box Qty
PI1206S-US	3/16"	0.67"	10	200
PI1208S-US	1/4"	0.67"	10	200
PM1208S-US	5/16"	0.83"	10	100
PI1212S-US	3/8"	0.83"	10	100
PI1216S-US	1/2"	1.06"	5	50

Bulkhead Reducing Union



Part Number	Tube OD	Tube OD	Mounting Hole Dia.	Bag Qty	Box Qty
PI121208S-US	3/8"	1/4"	0.83"	10	150
NC392-02-US	1/2"	1/4"	0.67"	150*	150

\*Bulk packed

# Fluid System Fittings Inch Acetal Gray

## Enlarger



Part Number	Stem OD	Tube OD	Bag Qty	Box Qty
PI131012S-US	5/16"	3/8"	10	250
PI131216S-US	3/8"	1/2"	10	200

## Reducing Union Connector



Part Number	Tube OD	Tube OD	Bag Qty	Box Qty
PI200806S-US	1/4"	3/16"	10	200
PM200804S-US	5/16"	5/32"	10	300
PI201006S-US	5/16"	3/16"	10	200
PI201008S-US	5/16"	1/4"	10	200
PI201206S-US	3/8"	3/16"	10	200
PI201208S-US	3/8"	1/4"	10	200
PI201210S-US	3/8"	5/16"	10	200
PI201608S-US	1/2"	1/4"	10	200
PI201610S-US	1/2"	5/16"	10	100
PI201612S-US	1/2"	3/8"	10	100

## Reducing Elbow



Part Number	Tube OD	Tube OD	Bag Qty	Box Qty
PM210804S-US	5/16"	5/32"	10	300
PI211006S-US	5/16"	3/16"	10	200
PI211008S-US	5/16"	1/4"	10	200
PI211206S-US	3/8"	3/16"	10	200
PI211208S-US	3/8"	1/4"	10	200
PI211210S-US	3/8"	5/16"	10	200
PI211610S-US	1/2"	5/16"	10	100
PI211612S-US	1/2"	3/8"	10	100

## Plug In Elbow



Part Number	Stem OD	Tube OD	Bag Qty	Box Qty
PM220404S-US	5/32"	5/32"	10	500
PI220606S-US	3/16"	3/16"	10	500
PI220808S-US	1/4"	1/4"	10	500
PM220808S-US	5/16"	5/16"	10	400
PI221206S-US	3/8"	3/16"	10	300
PI221208S-US	3/8"	1/4"	10	300
PI221210S-US	3/8"	5/16"	10	200
PI221212S-US	3/8"	3/8"	10	200
PI221616S-US	1/2"	1/2"	10	100

## Two Way Divider



Part Number	Tube OD	Bag Qty	Box Qty
PI2308S-US	1/4"	10	150
PM2308S-US	5/16"	10	100
PI2312S-US	3/8"	10	100
PI2316S-US	1/2"	5	100

## Reducing Two Way Divider



Part Number	Tube OD Inlet	Tube OD Outlet	Bag Qty	Box Qty
PI241210S-US	3/8"	5/16"	10	100

# Fluid System Fittings Inch Acetal Gray

## Tube To Hose Stem



Part Number	Stem OD	Hose ID	Bag Qty	Box Qty
PI250806S-US	1/4"	3/16"	10	500
PI250808S-US	1/4"	1/4"	10	500
PI250810S-US	1/4"	5/16"	10	500
PI251006S-US	5/16"	3/16"	10	500
PI251008S-US	5/16"	1/4"	10	500
PM250808S-US	5/16"	5/16"	10	500
PI251012S-US	5/16"	3/8"	10	400
PI251208S-US	3/8"	1/4"	10	400
PI251210S-US	3/8"	5/16"	10	400
PI251212S-US	3/8"	3/8"	10	400
PI251216S-US	3/8"	1/2"	10	300
PI251612S-US	1/2"	3/8"	10	300
PI251616S-US	1/2"	1/2"	10	200

## Tube to Hose Stem Long Version



Part Number	Stem OD	Hose ID	Bag Qty	Box Qty
PI251012SL	5/16"	3/8"	10	400
PI251212SL-US	3/8"	3/8"	10	400

## Tube to Hose Elbow



Part Number	Stem OD	Hose ID	Bag Qty	Box Qty
PI290808S-US	1/4"	1/4"	10	500
PI290810S-US	1/4"	5/16"	10	500
PI291008S-US	5/16"	1/4"	10	500
PM290808S-US	5/16"	5/16"	10	500
PI291208S-US	3/8"	1/4"	10	400
PI291210S-US	3/8"	5/16"	10	400

# Fluid System Fittings Inch Acetal Gray

## Reducing Tee



Part Number	Tube OD Ends	Tube OD Branch	Bag Qty	Box Qty
PI301208S-US	3/8"	1/4"	10	150
PI301612S-US	1/2"	3/8"	10	50

## Female Connector NPTF Thread



Part Number	Tube OD	Thread NPTF	Bag Qty	Box Qty
PI450822S-US	1/4"	1/4"	10	400
PI451222S-US	3/8"	1/4"	10	250

## Female Connector BSPP Thread - Cone End

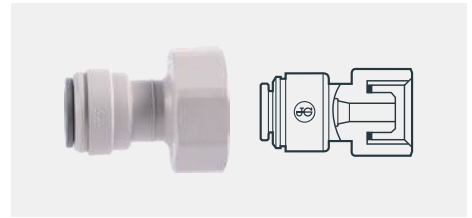

Part Number	Tube OD	Thread BSPP	Bag Qty	Box Qty
PI451015CS	5/16"	5/8"	10	150
PI451214CS-US	3/8"	1/2"	10	150
PI451215CS-US	3/8"	5/8"	10	100
PI451614CS-US	1/2"	1/2"	10	150
PI451616CS-US	1/2"	3/4"	10	100

## Female Connector BSPP Thread - Flat End

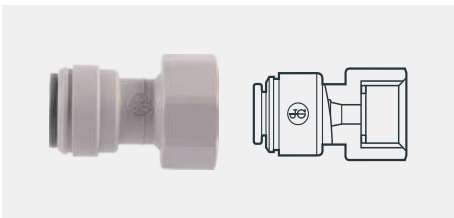

Part Number	Tube OD	Thread BSPP	Bag Qty	Box Qty
PI451014FS-US	5/16"	1/2"	10	150
PI451015FS-US	5/16"	5/8"	10	150
PI451213S-US	3/8"	3/8"	10	150
PI451214FS-US	3/8"	1/2"	10	150
PI451215FS-US	3/8"	5/8"	10	150
PI451613S-US	1/2"	3/8"	10	150
PI451615FS-US	1/2"	5/8"	10	150

## Female Connector UN Thread



Part Number	Tube OD	Thread UN	Bag Qty	Box Qty
PM4508C5S-US	5/16"	1/2"-16	10	200
PI4512C5S-US	3/8"	1/2"-16	10	200
PI4516C5S-US	1/2"	1/2"-16	10	200

## Female Flare Connector FFL Thread - 45° Flare

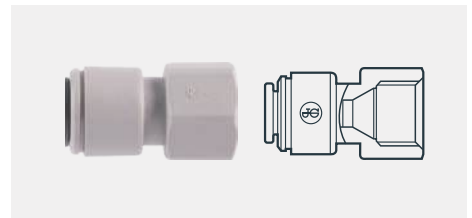

Part Number	Tube OD	Thread FFL	Bag Qty	Box Qty
PM4508F4S-US	5/16"	1/4"	10	300
PI4512F4S-US	3/8"	1/4"	10	250
PI4512F6S-US	3/8"	3/8"	10	200

1/4 (FFL) corresponds to a 7/16 - 20 UNF  
3/8 (FFL) corresponds to a 5/8 - 18 UNF



# Fluid System Fittings

## Inch Acetal Gray

### Faucet Connector BSP Thread

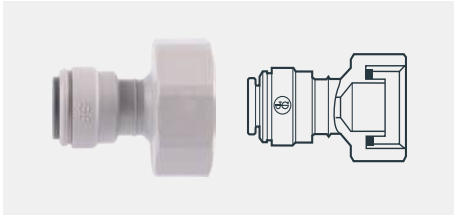

Part Number	Tube OD	Thread BSP	Bag Qty	Box Qty
CI320814S-US	1/4"	1/2"	10	150
CI320816S-US	1/4"	3/4"	10	150
CI321214S-US	3/8"	1/2"	10	100
CI321216S-US	3/8"	3/4"	10	100

Not suitable for air

### Female Connector BSP Thread

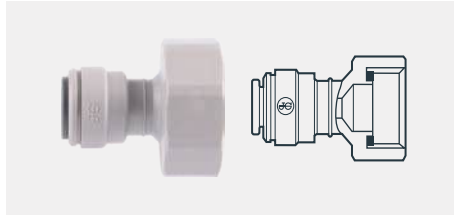

Part Number	Tube OD	Thread BSP	Bag Qty	Box Qty
CI320816FS-US	1/4"	3/4"	10	150
CI321216FS-US	3/8"	3/4"	10	100

Not suitable for air

### Faucet Connector UNS Thread



Part Number	Tube OD	Thread UNS	Bag Qty	Box Qty
CI3208U7S-US	1/4"	7/16"-24	10	250
CI3210U7S-US	5/16"	7/16"-24	10	300
CI3212U7S-US	3/8"	7/16"-24	10	200

Not suitable for air  
7/16 - 24 UNS = 1/4 Compression Threads

### End Cap



Part Number	Tube OD	Bag Qty	Box Qty
PI4608S-US	1/4"	10	500
PI4612S-US	3/8"	10	500

### Cross



Part Number	Tube OD	Bag Qty	Box Qty
PI4712S-US	3/8"	10	100

### Three Way Divider



Part Number	Tube OD Inlet	Tube OD Outlet	Bag Qty	Box Qty
PI491212S-R-US	3/8"	3/8"	50	50
PI491612S-US	1/2"	3/8"	10	50
PI491616S-US	1/2"	1/2"	5	40

-R denotes red collet

# Fluid Systems Fittings Inch Acetal Gray

## Fixed Elbow NPTF Thread



Part Number	Tube OD	Thread NPTF	Bag Qty	Box Qty
PI480821S-US	1/4"	1/8"	10	500
PI480822S-US	1/4"	1/4"	10	400
PI480823S-US	1/4"	3/8"	10	300
PI481022S-US	5/16"	1/4"	10	300
PI481023S-US	5/16"	3/8"	10	300
PI481222S-US	3/8"	1/4"	10	200
PI481223S-US	3/8"	3/8"	10	200
PI482024S-US	5/8"	1/2"	10	100

## U-Bend



Part Number	Tube OD	Bag Qty	Box Qty
PIUB12S-US	3/8"	10	100
PIUB16S-US	1/2"	10	50

Existing 1/2" ID lines can be accommodated by using a standard Tube to Hose Stem.

## John Guest Adaptability

Standard John Guest fittings can be coupled together to form integral new fittings.

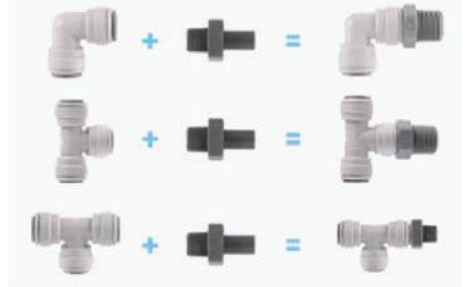

# Fluid System Fittings

## Inch Acetal White

The CI Range of inch-size push-fit fittings is offered for tube sizes 1/4" OD to 3/8" OD. These fittings are manufactured in white acetal, with a food grade EPDM O-ring. They have been developed for the water industry, but are equally suitable for other potable liquids. They are also recommended for intermittent hot water applications.

### Working pressures and temperatures

Water      Max. 150 psi at 70 °F (Max. 10 bar at 20 °C)  
               Max. 100 psi at 150 °F (Max. 7 bar at 65 °C)  
               Min. 33 °F/1 °C



**NOT suitable for compressed air applications. For these situations, we recommend the PI Range on pages 19 - 26.**

For general technical specifications, refer to page 76.

### Male Connector NPTF Thread



Part Number	Tube OD	Thread NPTF	Bag Qty	Box Qty
CI010821W-US	1/4"	1/8"	10	500
CI010822W-US	1/4"	1/4"	10	400
CI010823W-US	1/4"	3/8"	10	300
CI011222W-US	3/8"	1/4"	10	250

### Union Tee



Part Number	Tube OD	Bag Qty	Box Qty
CI0208W-US	1/4"	10	300
CI0212W-US	1/4"	10	100

### Union Elbow



Part Number	Tube OD	Bag Qty	Box Qty
CI0308W-US	1/4"	10	400
CI0312W-US	3/8"	10	200

### Union Connector



Part Number	Tube OD	Bag Qty	Box Qty
CI0408W-US	1/4"	10	400
CI0412W-US	3/8"	10	200

### Stem Adapter NPTF Thread



Part Number	Stem OD	Thread NPTF	Bag Qty	Box Qty
CI050821W-US	1/4"	1/8"	10	500
CI050822W-US	1/4"	1/4"	10	500
CI051222W-US	3/8"	1/4"	10	300
CI051223W-US	3/8"	3/8"	10	300

### Reducer



Part Number	Stem OD	Thread NPTF	Bag Qty	Box Qty
CI061208W-US	3/8"	1/4"	10	400

# Fluid Systems Fittings Inch Acetal White

## Bulkhead Union



Part Number	Tube OD	Mounting Hole Dia.	Bag Qty	Box Qty
CI1208W-US	1/4"	0.67"	10	200

## Plug In Elbow



Part Number	Stem OD	Tube OD	Bag Qty	Box Qty
CI220808W-US	1/4"	1/4"	10	500
CI221208W-US	3/8"	1/4"	10	300
CI221212W-US	3/8"	3/8"	10	200

## Barb Connector



Part Number	Superseal OD	Hose ID	Bag Qty	Box Qty
CI270808W-US	1/4"	1/4"	10	300

## Tube to Hose Elbow



Part Number	Stem OD	Hose ID	Bag Qty	Box Qty
CI291208W-US	3/8"	1/4"	10	400

## Female Adapter

BSPP Thread - Flat End



Part Number	Tube OD	Thread BSPP	Bag Qty	Box Qty
CI450814FW-US	1/4"	1/2"	10	150

## Female Adapter

NPTF Thread



Part Number	Tube OD	Thread NPTF	Bag Qty	Box Qty
CI451222W	3/8"	1/4"	10	250

## Fixed Elbow

NPTF Thread



Part Number	Tube OD	Thread NPTF	Bag Qty	Box Qty
CI480821W-US	1/4"	1/8"	10	500
CI480822W-US	1/4"	1/4"	10	400
CI480823W-US	1/4"	3/8"	10	300
CI481222W-US	3/8"	1/4"	10	200

## Stackable Tee



Part Number	Tube OD Inlet	Stem OD	Tube OD Outlet	Bag Qty	Box Qty
CI530808W-US	1/4"	1/4"	1/4"	10	300

## Branch Stem Tee



Part Number	Tube OD	Tube OD	Stem OD	Bag Qty	Box Qty
CI580808W-US	1/4"	1/4"	1/4"	10	300

# Fluid System Fittings

## Inch Superseal

For use with Stainless Steel Tubing

The SI Range of inch-size push-fit fittings is offered for tube sizes 1/4" OD to 3/8" OD. Superseal is a special fitting designed to provide extra grip on stainless steel tubes. The Superseal design features a collet with integrally molded stainless steel teeth similar to the standard Super Speedfit/Push-Fit design, but incorporates an additional hand-operated nut and wedge-shaped plastic washer to apply extra pressure to the collet and the double O-ring seals. This causes the collet teeth to bite thoroughly into the tube to provide grip, while at the same time, compressing the O-rings to further enhance sealing.

Superseal is suitable for potable liquids and other food quality applications.

### Working pressures and temperatures

1/4"- 5/16": Max. 230 psi at 68°F    3/8": Max. 150 psi at 68°F  
 Max. 150 psi at 150°F                      Max. 100 psi at 150°F

For general technical specifications, refer to page 76.

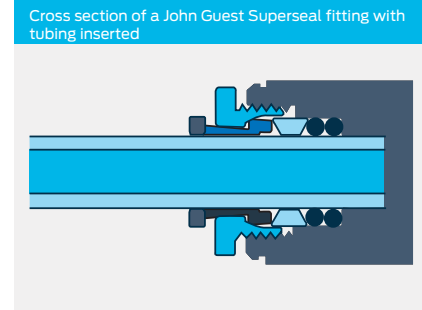

**Male Connector**  
BSPT Thread



Part Number	Superseal OD	Thread BSPT	Bag Qty	Box Qty
SM010802S	5/16"	1/4"	10	200

**Male Connector**  
BSPP Thread



Part Number	Superseal OD	Thread BSPP	Bag Qty	Box Qty
SM010812S	5/16"	1/4"	10	200

**Flare Male Connector**  
MFL Thread



Part Number	Superseal OD	Thread MFL	Bag Qty	Box Qty
SM0108F4S	5/16"	1/4"	10	200

**Union Elbow**  
Superseal - Speedfit



Part Number	Superseal OD	Speedfit OD	Bag Qty	Box Qty
SI030812S-US	1/4"	3/8"	10	150
SM030808S-US	5/16"	5/16"	10	200
SI031012S-US	5/16"	3/8"	10	150
SI031210S	3/8"	5/16"	10	150
SI031212S-US	3/8"	3/8"	10	150

**Union Elbow**  
Superseal - Superseal



Part Number	Superseal OD	Superseal OD	Bag Qty	Box Qty
SM400808S-US	5/16"	5/16"	10	150
SI401210S-US	3/8"	5/16"	10	150
SI401212S-US	3/8"	3/8"	10	150

**Union Connector**  
Superseal - Speedfit



Part Number	Superseal OD	Speedfit OD	Bag Qty	Box Qty
SM040808S-US	5/16"	5/16"	10	200
SI041012S-US	5/16"	3/8"	10	200
SI041210S-US	3/8"	5/16"	10	200
SI041212S-US	3/8"	3/8"	10	200
SI041216S	3/8"	1/2"	10	150

# Fluid System Fittings Inch Superseal

## Union Connector Superseal - Superseal



Part Number	Superseal OD	Bag Qty	Box Qty
SM410808E-US	5/16"	10	200

## Barb Connector



Part Number	Superseal OD	Hose ID	Bag Qty	Box Qty
SI270808S-US	1/4"	1/4"	10	300
SI271008S-US	5/16"	1/4"	10	250
SI271208S-US	3/8"	1/4"	10	200

## Flow Bend Connector Superseal - Speedfit



Part Number	Superseal OD	Speedfit OD	Bag Qty	Box Qty
SM420808S	5/16"	5/16"	10	100
SI421012S-US	5/16"	3/8"	10	100
SI421210S	3/8"	5/16"	10	100
SI421212S-US	3/8"	3/8"	10	100

## Spanner For Superseal Fittings



Part Number	Size	Bag Qty	Box Qty
SPANI-US	1/4-5/16" & 3/8"	1	100

The Spanner is for use when securing Superseal fittings to stainless steel tubing. One side is for use with a 1/4" and 5/16" Superseal fittings and the other side works with a 3/8" Superseal fitting.

# Fluid System Fittings Inch Brass

Designed for use in coffee brewing equipment, beverage dispensing and vending machine applications, these fittings are manufactured in brass with a polypropylene collet and a food grade EPDM O-ring.

## Working pressures and temperatures

Water Max. 150 psi at 70 °F (Max. 10 bar at 20 °C)  
 Max. 60 psi at 140 °F (Max. 4 bar at 60 °C)  
 Min. 33 °F/1 °C



**NOT suitable for compressed air applications.**

For general technical specifications, refer to page 76.

### Flare Female Connector FFL Thread



Part Number	Tube OD	Thread FFL	Bag Qty	Box Qty
MI4508F4SLF-US	1/4"	1/4"	10	200
MI4512F4SLF-US	3/8"	1/4"	10	200
MI4512F6SLF-US	3/8"	3/8"	10	100

1/4 (FFL) corresponds to a 7/16-20 UNF  
 3/8 (FFL) corresponds to a 5/8-18 UNF

### Female Connector Garden Hose - NH Thread



Part Number	Tube OD	Thread NH	Bag Qty	Box Qty
NC2098LF-US	1/4"	3/4"-11.5	10	100

A plug in elbow shown on page 15 will provide a neat 90° installation. The tube can be oriented in any direction.

### Female Connector Brass/Polypropylene Garden Hose - NH Thread



Part Number	Tube OD	Thread NH	Bag Qty	Box Qty
NC2258-US	3/8"	3/4"-11.5	10	100

Threaded brass ring is not a wetted surface.

### Female Connector Brass/Polypropylene - BSPP Thread



Part Number	Tube OD	Thread BSPP	Bag Qty	Box Qty
NC2145LF-US	1/4"	3/4"	10	150
NC2249LF-US	3/8"	3/4"	10	100

### Female Connector



Part Number	Size OD x UNEF	Bag Qty	Box Qty
PSEI6012U9-US	3/8" 9/16"-24	10	200

9/16 - 24 UNEF = 3/8 Compression Threads

### Male Connector



Part Number	Size OD x UNEF	Bag Qty	Box Qty
PSEI0112U9-US	3/8" 9/16"-24	10	300

9/16 - 24 UNEF = 3/8 Compression Threads

# Fluid System Fittings Metric to Inch

These fittings are designed to convert applications from metric to inch sizes and are suitable for various applications.

## Working pressures and temperatures

Water Max. 150 psi at 70 °F (Max. 10 bar at 20 °C)  
 Max. 60 psi at 140 °F (Max. 4 bar at 60 °C)  
 Min. 33 °F/1 °C



**NOT suitable for compressed air applications.**

### Stem to Tube Adapter



Part Number	Stem OD	Tube OD	Bag Qty	Box Qty
NC2164-US	15mm	3/8"	10	200
NC2173-US	1/2"	15mm	10	100

### Acetal Union Connector EDPM O-ring



Part Number	Tube OD	Tube OD	Bag Qty	Box Qty
NC2511-US	15mm	3/8"	10	100

### Barb Connector



Part Number	Tube OD	Hose ID	Bag Qty	Box Qty
NC448-US	15mm	1/2"	10	1000

### Conversion Union Connector



Part Number	Tube OD	Tube OD	Bag Qty	Box Qty
NC462-US	15mm	1/2"	10	400

### Stem to Stem Adapter



Part Number	Stem OD	Stem OD	Bag Qty	Box Qty
NC478-US	15mm	3/8"	10	150

### Tee Adapter



Part Number	Tube OD	Tube OD	Bag Qty	Box Qty
NC869-US	15mm	3/8"	-	400

### Tube to Hose Stem



Part Number	Stem OD	Hose ID	Bag Qty	Box Qty
NC932-US	15mm	1/2"	10	150

### Straight Connector



Part Number	Speedfit OD	Superseal OD	Bag Qty	Box Qty
NC2301	15mm	1/2"	10	80



# Fluid System Fittings

## Metric Polypropylene White

The PPM Range of metric size push-fit fittings is offered for tube sizes 8mm OD to 15mm OD. These fittings are manufactured in white polypropylene with EPDM O-rings. They have been developed to satisfy compatibility needs for a wide range of applications.

### Working pressures and temperatures

Water Max. 150 psi at 70 °F (Max. 10 bar at 20 °C)  
 Max. 60 psi at 140 °F (Max. 4 bar at 60 °C)  
 Min. 33 °F/1 °C

**NOT suitable for compressed air applications. For these situations, we recommend the PM Range on pages 35-39.**

For general technical specifications, refer to page 76.



### Union Tee



Part Number	Tube OD	Bag Qty	Box Qty
PPM0208W	8mm	10	200
PPM0212W-US	12mm	10	80

### Union Elbow



Part Number	Tube OD	Bag Qty	Box Qty
PPM0308W-US	8mm	10	300
PPM0312W-US	12mm	10	100

### Union Connector



Part Number	Tube OD	Bag Qty	Box Qty
PPM0408W-US	8mm	10	300
PPM0412W-US	12mm	10	100

### Reducer



Part Number	Stem OD	Tube OD	Bag Qty	Box Qty
PPM061512W	15mm	12mm	10	150

### Plug



Part Number	Tube OD	Bag Qty	Box Qty
PPM0808W-US	8mm	10	500

### Reducing Union Connector



Part Number	Tube OD	Tube OD	Bag Qty	Box Qty
PPM201512W-US	15mm	12mm	10	100

### Plug In Elbow



Part Number	Stem OD	Tube OD	Bag Qty	Box Qty
PPM220808W-US	8mm	8mm	10	400
PPM221212W-US	12mm	12mm	10	100

### Two Way Divider



Part Number	Tube OD	Bag Qty	Box Qty
PPM2312W-US	12mm	10	80

Adapters to convert to inch sizes are shown on page 33.

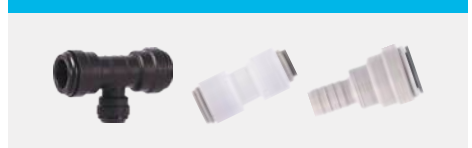

# Fluid System Fittings

## Metric Acetal Black

The PM Range of metric size push-fit fittings is offered for tube sizes 4mm OD to 28mm OD. These fittings are manufactured in black acetal copolymer with food grade nitrile O-rings. Especially produced for foodstuffs and potable liquids, they are equally suitable for air and inert gases and can, therefore, be used on CO<sub>2</sub> lines, pneumatics applications and vacuum.

### Working pressures and temperatures

**4-8mm:** Max. 230 psi at 68° F      **10-28mm:** Max. 150 psi at 68° F  
 Max. 150 psi at 150° F                      Max. 100 psi at 150° F

For general technical specifications, refer to page 76.



NSF 51  
NSF 61

### Male Connector NPTF Thread



Part Number	Tube OD	Thread NPTF	Bag Qty	Box Qty
PM010622E-US	6mm	1/4"	10	500

### Male Connector BSPT Thread



Part Number	Tube OD	Thread BSPT	Bag Qty	Box Qty
PM010401E-US	4mm	1/8"	10	500
PM010402E	4mm	1/4"	10	500
PM010501E	5mm	1/8"	10	500
PM010502E-US	5mm	1/4"	10	500
PM010601E-US	6mm	1/8"	10	500
PM010602E-US	6mm	1/4"	10	500
PM010801E-US	8mm	1/8"	10	400
PM010802E-US	8mm	1/4"	10	400
PM010803E-US	8mm	3/8"	10	300
PM011002E-US	10mm	1/4"	10	250
PM011003E-US	10mm	3/8"	10	250
PM011004E-US	10mm	1/2"	10	200
PM011203E-US	12mm	3/8"	10	150
PM011204E-US	12mm	1/2"	10	150

### Male Connector BSPP Thread



Part Number	Tube OD	Thread BSPP	Bag Qty	Box Qty
PM010411E-US	4mm	1/8"	10	500
PM010412E	4mm	1/4"	10	500
PM010511E-US	5mm	1/8"	10	500
PM010512E	5mm	1/4"	10	500
PM010611E-US	6mm	1/8"	10	500
PM010612E-US	6mm	1/4"	10	500
PM010811E-US	8mm	1/8"	10	400
PM010812E-US	8mm	1/4"	10	400
PM010813E-US	8mm	3/8"	10	300
PM011012E-US	10mm	1/4"	10	250
PM011013E-US	10mm	3/8"	10	250
PM011014E-US	10mm	1/2"	10	200
PM011213E-US	12mm	3/8"	10	150
PM011214E-US	12mm	1/2"	10	150
PM011513E-US	15mm	3/8"	10	150
PM011514E-US	15mm	1/2"	10	150
PM011516E-US	15mm	3/4"	10	50
PM011814E-US	18mm	1/2"	70	70
PM012216E-US	22mm	3/4"	50	50

# Fluid Systems Fittings Metric Acetal Black

## Union Tee



Part Number	Tube OD	Bag Qty	Box Qty
PM0204E-US	4mm	10	400
PM0205E-US	5mm	10	400
PM0206E-US	6mm	10	300
PM0208E-US	8mm	10	200
PM0210E-US	10mm	10	100
PM0212E-US	12mm	10	50
PM0215E-US	15mm	5	50
PM0218E-US	18mm	5	30
PM0222E-US	22mm	5	20
PM0228E-US	28mm	10	10

## Union Elbow



Part Number	Tube OD	Bag Qty	Box Qty
PM0304E	4mm	10	500
PM0305E-US	5mm	10	500
PM0306E-US	6mm	10	400
PM0308E-US	8mm	10	300
PM0310E-US	10mm	10	200
PM0312E-US	12mm	10	100
PM0315E-US	15mm	10	50
PM0318E-US	18mm	5	50
PM0322E-US	22mm	5	30
PM0328E-US	28mm	20	20

## Union Connector



Part Number	Tube OD	Bag Qty	Box Qty
PM0404E-US	4mm	10	500
PM0405E-US	5mm	10	500
PM0406E-US	6mm	10	400
PM0408E-US	8mm	10	300
PM0410E-US	10mm	10	200
PM0412E-US	12mm	10	100
PM0415E-US	15mm	10	100
PM0418E-US	18mm	10	50
PM0422E-US	22mm	10	50
PM0428E-US	28mm	25	25

## Stem Adapter BSPT Thread



Part Number	Stem OD	Thread BSPT	Bag Qty	Box Qty
PM050401E	4mm	1/8"	10	500
PM050402E	4mm	1/4"	10	500
PM050501E	5mm	1/8"	10	500
PM050502E	5mm	1/4"	10	500
PM050601E-US	6mm	1/8"	10	500
PM050602E-US	6mm	1/4"	10	500
PM050801E-US	8mm	1/8"	10	500
PM050802E	8mm	1/4"	10	500
PM050803E-US	8mm	3/8"	10	300
PM051002E-US	10mm	1/4"	10	300
PM051003E	10mm	3/8"	10	300
PM051004E-US	10mm	1/2"	10	200
PM051203E-US	12mm	3/8"	10	200
PM051204E	12mm	1/2"	10	150

## Stem Adapter BSPP Thread



Part Number	Stem OD	Thread BSPP	Bag Qty	Box Qty
PM050411E	4mm	1/8"	10	500
PM050412E	4mm	1/4"	10	500
PM050511E	5mm	1/8"	10	500
PM050512E	5mm	1/4"	10	500
PM050611E	6mm	1/8"	10	500
PM050612E-US	6mm	1/4"	10	500
PM050811E-US	8mm	1/8"	10	500
PM050812E-US	8mm	1/4"	10	500
PM050813E-US	8mm	3/8"	10	300
PM051012E-US	10mm	1/4"	10	300
PM051013E-US	10mm	3/8"	10	300
PM051213E	12mm	3/8"	10	200
PM051214E-US	12mm	1/2"	10	200
PM051513E-US	15mm	3/8"	10	150
PM051514E-US	15mm	1/2"	10	150
PM051814E-US	18mm	1/2"	10	100
PM052214E-US	22mm	1/2"	10	100
PM052216E-US	22mm	3/4"	10	100

## Reducer



Part Number	Stem OD	Tube OD	Bag Qty	Box Qty
PM060504E	5mm	4mm	10	500
PM060604E-US	6mm	4mm	10	500
PM060605E-US	6mm	5mm	10	500
PM060804E-US	8mm	4mm	10	500
PM060805E	8mm	5mm	10	500
PM060806E-US	8mm	6mm	10	500
PM061006E-US	10mm	6mm	10	400
PM061008E-US	10mm	8mm	10	400
PM061208E-US	12mm	8mm	10	300
PM061210E-US	12mm	10mm	10	250
PM061510E	15mm	10mm	10	200
PM061512E-US	15mm	12mm	10	100
PM062215E-US	22mm	15mm	10	50
PM062218E-US	22mm	18mm	10	50
PM062815E-US	28mm	15mm	10	50
PM062822E-US	28mm	22mm	50	50

# Fluid Systems

## Fittings

### Metric Acetal Black

#### Plug



Part Number	Tube OD	Bag Qty	Box Qty
PM0804R-US	4mm	10	1000
PM0805R-US	5mm	10	1000
PM0806R-US	6mm	10	500
PM0808R-US	8mm	10	500
PM0810R-US	10mm	10	400
PM0812R-US	12mm	10	300

R denotes red plug

#### Swivel Male Elbow

BSPT Thread



Part Number	Tube OD	Thread BSPT	Bag Qty	Box Qty
PM090401E	4mm	1/8"	10	400
PM090402E	4mm	1/4"	10	200
PM090501E-US	5mm	1/8"	10	400
PM090502E	5mm	1/4"	10	200
PM090601E-US	6mm	1/8"	10	200
PM090602E-US	6mm	1/4"	10	200
PM090801E-US	8mm	1/8"	10	200
PM090802E-US	8mm	1/4"	10	200
PM090803E-US	8mm	3/8"	10	200
PM091002E-US	10mm	1/4"	10	100
PM091003E-US	10mm	3/8"	10	100
PM091004E-US	10mm	1/2"	10	100
PM091203E-US	12mm	3/8"	10	50
PM091204E-US	12mm	1/2"	10	50

#### Swivel Male Elbow

BSPP Thread



Part Number	Tube OD	Thread BSPP	Bag Qty	Box Qty
PM09041E-US	4mm	1/8"	10	400
PM09042E-US	4mm	1/4"	10	200
PM090512E	5mm	1/4"	10	200
PM090611E-US	6mm	1/8"	10	200
PM09062E-US	6mm	1/4"	10	200
PM090811E-US	8mm	1/8"	10	200
PM09082E-US	8mm	1/4"	10	200
PM09083E-US	8mm	3/8"	10	200
PM091012E-US	10mm	1/4"	10	100
PM09103E-US	10mm	3/8"	10	100
PM09104E-US	10mm	1/2"	10	100
PM091213E	12mm	3/8"	10	50
PM09124E-US	12mm	1/2"	10	50

#### Swivel Male Branch Tee

BSPT Thread



Part Number	Tube OD	Thread BSPT	Bag Qty	Box Qty
PM100402E	4mm	1/4"	10	200
PM100502E	5mm	1/4"	10	200
PM100601E	6mm	1/8"	10	200
PM100602E	6mm	1/4"	10	200
PM100801E	8mm	1/8"	10	100
PM100802E	8mm	1/4"	10	100
PM100803S	5/16"	3/8"	10	100
PM101002E	10mm	1/4"	10	100
PM101003E-US	10mm	3/8"	10	100
PM101204E	12mm	1/2"	5	50

#### Swivel Male Branch Tee

BSPP Thread

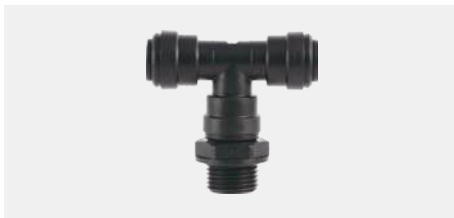

Part Number	Tube OD	Thread BSPP	Bag Qty	Box Qty
PM10041E	4mm	1/8"	10	200
PM100512E	5mm	1/4"	10	200
PM10061E	6mm	1/8"	10	200
PM10062E	6mm	1/4"	10	200
PM10081E	8mm	1/8"	10	100
PM10082E	8mm	1/4"	10	100
PM10083E-US	8mm	3/8"	10	100
PM101012E	10mm	1/4"	10	100
PM101014E	10mm	1/2"	10	50
PM101213E-US	12mm	3/8"	5	50
PM10124E	12mm	1/2"	5	50

#### Swivel Male Run Tee

BSPT Thread



Part Number	Tube OD	Thread BSPT	Bag Qty	Box Qty
PM110602E-US	6mm	1/4"	10	200
PM110802E	8mm	1/4"	10	100

# Fluid Systems Fittings Metric Acetal Black

## Swivel Male Run Tee BSPP Thread



Part Number	Tube OD	Thread BSPP	Bag Qty	Box Qty
PM110411E	4mm	1/8"	10	200
PM110611E	6mm	1/8"	10	200
PM110612E	6mm	1/4"	10	200
PM110812E-US	8mm	1/4"	10	100
PM111012E-US	10mm	1/4"	10	100
PM111213E	12mm	3/8"	5	50

## Bulkhead Union



Part Number	Tube OD	Mounting Hole Dia.	Bag Qty	Box Qty
PM1204E-US	4mm	16.5mm	10	200
PM1205E	5mm	16.5mm	10	200
PM1206E-US	6mm	16.5mm	10	200
PM1208E-US	8mm	21.0mm	10	100
PM1210E-US	10mm	21.0mm	10	100
PM1212E-US	12mm	26.5mm	5	50

## Reducing Union Connector



Part Number	Tube OD	Tube OD	Bag Qty	Box Qty
PM200604E-US	6mm	4mm	10	400
PM200804E	8mm	4mm	10	300
PM200806E-US	8mm	6mm	10	200
PM201004E-US	10mm	4mm	10	200
PM201006E-US	10mm	6mm	10	200
PM201008E-US	10mm	8mm	10	200
PM201208E-US	12mm	8mm	10	100
PM201210E-US	12mm	10mm	10	100

## Reducing Elbow



Part Number	Tube OD	Tube OD	Bag Qty	Box Qty
PM210604E-US	6mm	4mm	10	400
PM210804E-US	8mm	4mm	10	300
PM210806E-US	8mm	6mm	10	200
PM211004E	10mm	4mm	10	200
PM211006E	10mm	6mm	10	200
PM211008E-US	10mm	8mm	10	200
PM211208E-US	12mm	8mm	10	100
PM211210E-US	12mm	10mm	10	100

## Plug In Elbow



Part Number	Stem OD	Tube OD	Bag Qty	Box Qty
PM220404E-US	4mm	4mm	10	500
PM220505E	5mm	5mm	10	500
PM220606E-US	6mm	6mm	10	500
PM220808E-US	8mm	8mm	10	400
PM221010E-US	10mm	10mm	10	200
PM221212E-US	12mm	12mm	10	100
PM221515E-US	15mm	15mm	10	100
PM222222E-US	22mm	22mm	10	50

# Fluid Systems Fittings Metric Acetal Black

## Two Way Divider



Part Number	Tube OD	Bag Qty	Box Qty
PM2304E	4mm	10	300
PM2308E-US	8mm	10	100
PM2310E-US	10mm	10	100
PM2315E	15mm	5	50

## Tube to Hose Stem



Part Number	Stem OD	Hose ID	Bag Qty	Box Qty
PM250604E-US	6mm	4mm	10	500
PM250806E	8mm	6mm	10	500
PM251008E-US	10mm	8mm	10	300

## Reducing Tee



Part Number	Tube OD Ends	Tube OD Branch	Bag Qty	Box Qty
PM3018AE-US	18mm	15mm	5	30
PM3022AE-US	22mm	15mm	5	20

## Female Connector BSPP Thread



Part Number	Tube OD	Thread BSPP	Bag Qty	Box Qty
PM450411E	4mm	1/8"	10	500
PM450611E	6mm	1/8"	10	500
PM450612E-US	6mm	1/4"	10	300
PM450812E-US	8mm	1/4"	10	300
PM450813E-US	8mm	3/8"	10	200
PM451015FE-US	10mm	5/8"	10	100
PM451215FE	12mm	5/8"	10	150

## End Cap



Part Number	Tube OD	Bag Qty	Box Qty
PM4612E-US	12mm	10	250
PM4615E-US	15mm	10	200
PM4618E-US	18mm	10	100
PM4622E-US	22mm	5	80

## Fixed Elbow NPTF Thread



Part Number	Tube OD	Thread NPTF	Bag Qty	Box Qty
PM480621E-US	6mm	1/8"	10	500
PM480622E-US	6mm	1/4"	10	400
PM480623E	6mm	3/8"	10	300

## U-Bend



Part Number	Tube OD	Bag Qty	Box Qty
PMUB15E-US	15mm	10	50

## John Guest Adaptability

Standard John Guest fittings can be coupled together to form integral new fittings.



# Fluid Systems

## Adapter Valves

# Angle Stop ASVPP

### Polypropylene with Chrome Threads

The ASVPP Range of inch-size angle stop adapter valves is offered in white polypropylene with food grade EPDM O-rings. Our Angle Stop Adapter Valve connects between the stop valve and riser to provide a water supply feed line, for applications in reverse osmosis, filtration systems, automatic coffee brewers, ice makers and many more.

### Working pressures and temperatures

Water Max. 150 psi at 70 °F (Max. 10 bar at 20 °C)  
Min. 33 °F/1 °C

**For cold water supply use only.**

**NOT suitable for compressed air, explosive gases, petroleum spirits and other fuels, or for heating systems.**

For general technical specifications, refer to page 76.



Angle Stop Adapter Valve



Part Number	Thread Male Compression	Thread Female Compression	Tube OD	Bag Qty	Box Qty
ASVPP1LF-US	3/8"	3/8"	1/4"	1	30
ASVPP2LF-US	3/8"	3/8"	3/8"	1	30

Suffix LF = Contains less than 0.25% lead

Angle Stop Adapter Valve  
Conversion Thread



Part Number	Thread Male/Female NPS	Thread Compression	Tube OD	Bag Qty	Box Qty
ASVPP5LF-US	1/2"	3/8"	1/4"	1	30
ASVPP6LF-US	1/2"	3/8"	3/8"	1	20

Suffix LF = Contains less than 0.25% lead

Conversion Adapter can be threaded to either side of valve to make configurations of 1/2" x 1/2" NPS or 3/8" x 3/8" compression

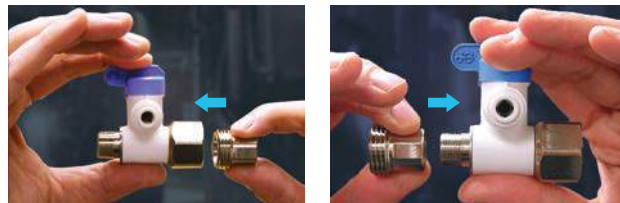

# Fluid Systems

## Adapter Valves

### Angle Stop PASV

Polypropylene with Polysulphone Threads

The PASV Range of inch-size angle stop adapter valves is offered in white polypropylene with polysulphone NPSM male threads. These valves are also available with a Female Conversion Adapter.

#### Working pressures and temperatures

Water Max. 145 psi at 68 °F (Max. 10 bar at 20 °C)  
 Max. 58 psi at 140 °F (Max. 4 bar at 60 °C)  
 Min. 34 °F/1 °C

**For cold water supply use only.**

**NOT suitable for compressed air, explosive gases, petroleum spirits and other fuels, or for heating systems.**

For general technical specifications, refer to page 76.



NSF 51  
NSF 61

**Angle Stop Adapter Valve**



Part Number	Thread Male Compression	Female Compression	Tube OD	Bag Qty	Box Qty
PASVPP1-US	3/8"	3/8"	1/4"	1	25
PASVPP2-US	3/8"	3/8"	3/8"	1	25

**Angle Stop Adapter Valve Conversion Thread**



Part Number	Thread Male/Female NPS	Female Compression	Tube OD	Bag Qty
PASVPP5-US	1/2"	3/8"	1/4"	1
PASVPP6-US	1/2"	3/8"	3/8"	1

Conversion Adapter can be threaded to either side of valve to make configuration of 1/2" x 1/2" NPS or 3/8" x 3/8" compression.

### 1/4 turn valves

These valves have been designed to allow temporary servicing of downstream equipment and must only be used in the fully open or fully closed position.

#### Do not use these valves:

- In a partially open position to control flow
- To provide a permanent termination
- Without tubing assembled or plugged (or threaded connections sealed)
- As a tap or "faucet"

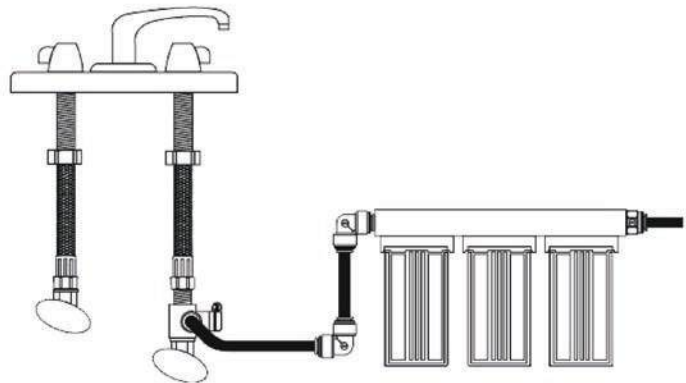



# Fluid System Shut-Off Valves Inch Polypropylene

The PPSV Range of inch-size shut-off valves is offered for tube sizes 1/4" OD and 3/8" OD. These valves are produced in white polypropylene and fitted with EPDM O-rings. Polypropylene has the advantage of being more chemically resistant than acetal. These valves are for use with potable water.

## Working pressures and temperatures

Water Max. 150 psi at 70 °F (Max. 10 bar at 20 °C)

Max. 60 psi at 140 °F (Max. 4 bar at 60 °C)

Min. 33 °F/1 °C

**NOT suitable for compressed air, explosive gases, petroleum spirits and other fuels, or for heating systems**

For general technical specifications, refer to page 76.



NSF 51  
NSF 61

### Shut-Off Valve (Male) Speedfit to Male (NPTF Thread)



Part Number	Tube OD	Thread NPTF	Bag Qty	Box Qty
PPSV010822W-US	1/4"	1/4"	200	200
PPSV011223W-US	3/8"	3/8"	100	100

### Straight Shut-Off Valve Speedfit to Speedfit



Part Number	Tube OD	Bag Qty	Box Qty
PPSV040808W-US	1/4"	200	200
PPSV041212W-US	3/8"	80	80

Also available in black. Use suffix E.

### Shut-Off Valve (Female) Speedfit to Female (NPTF Thread)



Part Number	Tube OD	Thread NPTF	Bag Qty	Box Qty
PPSV451223W	3/8"	3/8"	80	80

Also available in black. Use suffix E.

### Shut-Off Valve (Female Elbow) Speedfit to Female (NPTF Thread)



Part Number	Tube OD	Thread NPTF	Bag Qty	Box Qty
PPSV500822W-US	1/4"	1/4"	200	200
PPSV501222W-US	3/8"	1/4"	100	100

● 1/4 Turn Valve indicated by this marker

# Fluid Systems Shut-Off Valves Inch Acetal

The PISV Range of inch-size shut-off valves is offered for tube sizes 3/8" OD and 1/2" OD. These valves are manufactured in gray acetal copolymer with a nitrile O-ring and are available with short and long handles to operate a 1/4 turn off action. Specifically designed for compressed air and potable liquids, the valves are ideal for CO<sub>2</sub> lines in beverage dispensing and for pneumatic applications.

## Working pressures and temperatures

Air	150 psi at -4°F (10 bar at -20°C)
Air/Potable Liquids	Max. 150 psi at 33°F (10 bar at 1°C)
	Max. 150 psi at 68°F (10 bar at 23°C)
	Max. 100 psi at 150°F (7 bar at 65°C)

**It is the customer's responsibility to make sure that the installation of John Guest™ fittings in CO<sub>2</sub> applications is performed in accordance with the relevant industry and government safety guidelines.**

For general technical specifications, refer to page 76.



Part Number	Tube OD	Bag Qty	Box Qty
PISV0412CS-US	3/8"	100	100



Part Number	Tube OD	Bag Qty	Box Qty
PISV0412S-US	3/8"	10	100
PISV0416S-US	1/2"	10	50



Part Number	Tube OD	Bag Qty	Box Qty
NC2555-US	3/8"	25	25

Features double O-rings in every Speedfit port



Part Number	Size OD	Bag Qty	Box Qty
SVMC-06-US	1/4"	200	200
SVMC-10-US	3/8"	100	100

The clip can be used with either acetal shut-off valve. When used with the short handle version, valves can be banked together.

# Fluid Systems Shut-Off & By-Pass Valves 1/2 Inch Acetal

Specifically manufactured in white acetal with EPDM O-rings, these valves have been developed to satisfy the requirements of the US Recreational Vehicle (RV) and Mobile Home (MH) markets.

### Working pressures and temperatures

Water Max. 150 psi at 70 °F (Max. 10 bar at 20 °C)  
 Max. 60 psi at 140 °F (Max. 4 bar at 60 °C)  
 Min. 34 °F/1 °C



**For hot and cold water supply use only.**

For general technical specifications, refer to page 76.

Straight Shut-Off Valve				By Pass Valve			
							
Part Number	Size CTS	Bag Qty	Box Qty	Part Number	Size CTS	Bag Qty	Box Qty
NC2390-US	1/2"	1	25	NC2391-LH-US	1/2"	1	25
				NC2391-RH-US	1/2"	1	25

-LH denotes black handle  
 -RH denotes gray handle

Not IAPMO Listed

• 1/4 Turn Valve indicated by this marker

# Fluid Systems Check Valves Inch Acetal

Check valves allow flow in one direction.

## Working pressures and temperatures

Potable Liquids      Max. 150 psi at 33° F (10 bar at 1° C)  
                                  Max. 150 psi at 68° F (10 bar at 23° C)  
                                  Max. 100 psi at 150° F (7 bar at 65° C)

**For liquids only.**

For general technical specifications, refer to page 76.



### Check Valve (White)



Part Number	Crack Pressure	Tube OD	Bag Qty	Box Qty
1/4SCV-US	0.3 PSI	1/4"	10	300
1/4SCV-R-US	0.3 PSI	1/4"	10	300
5/16SCV-US	0.3 PSI	5/16"	10	300
NC2718-US	5 PSI	1/4"	10	300

-R denotes red collet

### Check Valve (Black)



Part Number	Crack Pressure	Tube OD	Bag Qty	Box Qty
NC2718E-US	5 PSI	1/4"	10	300

### Check Valve (Red Cap)



Part Number	Crack Pressure	Tube OD	Bag Qty	Box Qty
3/8SCV-US	0.3 PSI	3/8"	1	80

### Check Valve (White)



Part Number	Crack Pressure	Tube OD	Bag Qty	Box Qty
1/2SCV-US	0.35 PSI	1/2"	10	100

### Elbow Check Valve



Part Number	Crack Pressure	Tube OD	Thread NPTF	Bag Qty	Box Qty
NC2811-US	0.3 PSI	1/4"	1/8"	10	500

# Fluid Systems Accessories Inch/Metric

## Collet Cover

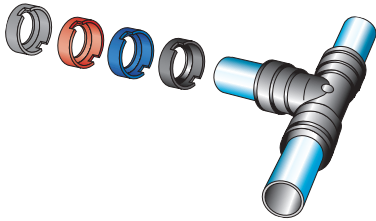

The slip-on Collet Cover shown in the illustration prevents accidental removal or tampering with tubing. Tubing can be inserted with the Collet Cover already attached to the fittings or the cover can slide into position afterwards. The cover is easily removed when required and comes in a variety of colors for color coding.

The following suffixes indicate colors available:

E = Black	S = Gray
R = Red	B = Blue

## Collet Cover - Inch Size

Part Number	Tube OD	Bag Qty	Box Qty
PI1906S	3/16"	10	1000
PI1908S-US	1/4"	10	1000
PM1908S	5/16"	10	1000
PI1912S-US	3/8"	10	500
PI1916S-US	1/2"	10	500

Please indicate required collet color by suffix, or gray will be supplied.

## Collet Cover - Metric Size

Part Number	Tube OD	Bag Qty	Box Qty
PM1906E	6mm	10	1000
PM1908E	8mm	10	1000
PM1912E	12mm	10	500
PM1915E-US	15mm	100	400
PM1922E	22mm	50	200

15mm to 22mm sizes are only available in black (standard), red or blue. Please indicate required collet color by suffix, or black will be supplied.

## Locking Clip



Part Number	Tube OD	Bag Qty	Box Qty
PIC1808R-US	1/4"	100	5000
PIC1812R-US	3/8"	100	1000
PIC1816R-US	1/2"	100	2000
PMC1808R-US	8mm	100	8000

## Flow Bend Clip



Part Number	Tube OD	Bag Qty	Box Qty
PM2608S-US	5/16" (8mm)	10	300
PM2610S-US	3/8" (10mm)	10	200

Designed to support tube and eliminate kinking



Secures collet in locked position to prevent accidental disconnection of tube. Locking Clips should be connected only after tubing is fully inserted to prevent scraping of the tube. Locking Clips are not designed for use with our Stem Adapters in Swivel Combinations.

# Fluid Systems Accessories Inch/Metric

## Mounting Clip For Acetal Shut-Off Valves



Part Number	Size OD	Bag Qty	Box Qty
SVMC-06-US	1/4"	200	200
SVMC-10-US	3/8"	100	100

Available for 3/8" OD valves  
The mounting clip is designed to give a very firm grip. A twisting action is needed to remove the valve. The clip can be used with either acetal shut-off valve. When used with the short handle version, valves can be banded together.

## Tube Insert



Part Number	Tube ID	Tube OD	Bag Qty	Box Qty
TSI250S-US	1/4"	5/16"	10	1000
TSI312S-US	5/16"	3/8"	100	2500
TSI375S-US	3/8"	1/2"	10	500
TSM15N-US	-	15mm	50	500
TSM22N	-	22mm	25	250
TSM28N	-	28mm	10	150

## Tube Cutter



Part Number	Description	Bag Qty	Box Qty
TSNIP	Tube Cutter	-	50
TSNIP-US	Tube Cutter	1	200
Blades-US	Blades Only	50	300

Suitable for up to 12mm tube or 1/2" tube

## Pipe Cutter



Part Number	Bag Qty	Box Qty
JG-TS-US	1	60

Suitable for up to 22mm pipe or 3/4" pipe

## Collet Locking/Release Tool



Part Number	Size	Bag Qty	Box Qty
ICLT/2-US	3/16" to 1/2"	1	50
TSPITool	1/4", 3/8"	10	50

# Fluid Systems Tubing LLDPE

The PE Range of plastic tubing is produced in linear low density polyethylene and is for use with cold and intermittent hot water applications. Our tubing is made from non-contaminating materials and provides the benefits of a wide range of temperature and pressure suitability and broad chemical compatibility. Common applications include water purification, water conditioners, ice makers and misting systems. LLDPE is more robust than traditional low or medium density polyethylene. Our tubing is made from FDA compliant materials and is NSF International certified.

LLDPE tubing provides excellent resistance to environmental stress cracking as measured by ASTM D-1693 (10% IGEPAL).

**Our polyethylene tubing is designed for use with our standard push-fit fittings, shut-off valves and virtually all standard tubing connectors.**



## Standard colors available

N = Natural

B = Blue



E = Black

R = Red



G = Green

O = Orange



W = White

Y = Yellow



15mm - only available in blue, red and green  
8mm - only available in natural, blue, black, red and white. For other colors, we suggest you use 5/16".

Black tubing - UV stabilized

### LLDPE Tubing sizes available:

Part Number	OD	ID	Coil Length	Min. Bend Radius
PE-08-BI-DF-N	1/4" (0.250")	0.170"	500'	1.00"
PE-08-BI-MF-N	1/4" (0.250")	0.170"	1000'	1.00"
PE-10-CI-DF-N	5/16" (0.312")	0.187"	500'	1.13"
PE-12-EI-DF-N	3/8" (0.375")	0.250"	500'	1.25"
PE-16-GI-CCLF-N	1/2" (0.500")	0.375"	250'	2.50"
PE-0425-CM-N	4mm	2.5mm	100m	25mm
PE-0604-CM-N	6mm	4mm	100m	25mm
PE-0806-CM-N	8mm	6mm	100m	30mm
PE-1007-CM-N	10mm	7mm	100m	32mm
PE-1209-CM-N	12mm	9mm	100m	63mm
PE-15115-CM-B	15mm	11.5mm	100m	100mm

Suffix indicates color.

To request other colors, please refer to adjacent table.

Popular items are generally in stock and are available for purchase in minimum quantities of 2 coils.

Other items may be subject to longer lead times and are available in minimum quantities of 50 coils.

### 25' Coils



Part Number	Tube OD	Coil Length	Bag Qty	Box Qty
PE-08-BI-025F-B	1/4"	25'	1	20
PE-08-BI-025F-N	1/4"	25'	1	20
PE-08-BI-025F-E	1/4"	25'	1	20
PE-12-EI-025F-B	3/8"	25'	1	12
PE-12-EI-025F-N	3/8"	25'	1	12

B = Blue

N = Natural

E = Black

# Fluid Systems Tubing LLDPE

## LLDPE working temperatures & pressures

Tube OD	Tube ID	
1/4" x	0.170"	
5/16" x	0.187"	
3/8" x	0.250"	230 psi @ 70°F
4mm x	2.5mm	120 psi @ 150°F
6mm x	4mm	
10mm x	7mm	
1/2" x	0.375"	
8mm x	6mm	150 psi @ 70°F
12mm x	9mm	90 psi @ 150°F
15mm x	11.5mm	

Burst pressures are approximately 3 times the maximum working pressure.

Maximum working temperature 150°F at pressures shown in chart. The chart's maximum temperatures and pressures do not take chlorine content into account. This could reduce useful service life.

Note, maximum pressure rating for a system depends on the lowest rated component, e.g., most John Guest fittings have a different rating from the tube ratings shown.

## Tube tolerances

1/4" to 1/2"	+0.001"/-0.004"
4mm	+0.05mm/-0.07mm
6mm to 12mm	+0.05mm/-0.10mm
15mm	+0.10mm/-0.10mm

## Pneumatics applications

Our LLDPE tubing is suitable for pneumatic applications, providing pressure is maximum 150psi @ 70°F (10 bar @ 20°C). At elevated temperatures 120°F+ (50°C+), mineral oil will degrade LLDPE tubing, which is why LLDPE tubing used in pneumatic circuits should be periodically checked and replaced when necessary.

## Tube inserts

If the tubing is used at elevated temperatures, tube inserts may be necessary.

## Exposure to ultraviolet light

Black LLDPE tubing is UV stabilized and can be exposed to direct ultraviolet light (e.g. direct sunlight); other colors of LLDPE tubing are not UV stabilized and cannot be exposed to direct ultraviolet light.

## Chemical resistance

For use of LLDPE tubing with chemicals or potentially aggressive liquids, please refer to our Technical Services Department.

NOTE: When using cleaning agents or other potentially aggressive liquids, check compatibility with tubing and fittings. LLDPE tubing is not recommended for mineral oils, gases and fuels or high pressure compressed air/pneumatic systems.

## Potable water applications

LLDPE tubing is suitable for potable cold water applications with a maximum chlorine content of 4 parts per million (4 ppm). Heating water above 70°F (20°C) and/or pressures above the maximum will significantly reduce useful service life. Direct exposure to sunlight will also significantly reduce its useful service. As part of good practice, tubing should be inspected regularly. If there is any evidence of damage, hardening or cracking, it should be replaced immediately.



# Fluid System Half Cartridges Plastic

- Available in inch and metric sizes
- Low assembly effort - high retention
- For filtration and food grade applications
- Compatible with a wide range of plastic and soft metal housing materials

Our Plastic Half Cartridges provide a quick, efficient and easy way of securing push-fit connections into a wide variety of original equipment. As the cartridge requires low insertion loads, it is suitable for many different housing materials.

As with all Speedfit products, the push-fit connection can be used with plastic or soft metal tubing in both inch and metric sizes. These half cartridges are suitable for a wide selection of original equipment, including manifolds and multi-interconnection points, Drinks Dispense and Water Purification Equipment.

**As Plastic Half Cartridges are intended for use by Original Equipment Manufacturers, they are only supplied in bulk quantities.**

The Plastic Half Cartridge is made up of three components:



1. A collet or gripper with stainless steel teeth to grip the tube

2. A body in food grade material, with stainless steel teeth that will grip into the housing of the equipment

3. An O-ring made from food grade material

Empty housing cavity:

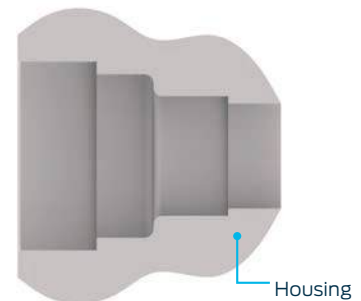

Completed assembly:

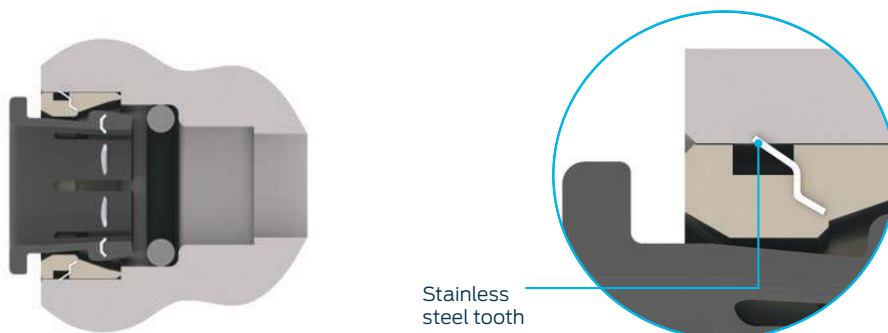

With the cartridge in its normal position the stainless steel teeth sink into the housing to a depth dependent upon the hardness of the housing material used.

When the system is under pressure the cartridge is held firmly in the body by the stainless steel teeth. These will sink in further as more pressure is applied.

# Fluid System Half Cartridges Plastic Tube OD & CTS

Plastic Half Cartridges have been designed to provide a simple, cost-effective method of integrating our push-fit technology into a wide variety of original equipment. The cartridge requires low insert loads, making it suitable for many different housing materials.

Plastic Half Cartridges consist of three components: a collet, an O-ring of food grade materials and a plastic body with stainless steel teeth molded into the circumference. Customers should make sure cartridges are suitable for their applications, materials and operating conditions.

**For Half Cartridges with double O-rings, please contact customer service.**

**For additional information, consult our technical support department.**

## Tube OD - Inch Series

Gray Acetal Collet - Gray Acetal Body - EPDM O-ring



Part Number	Tube OD	Box Qty
PCI2808S-US	1/4"	1000
PCM2808S-US	5/16"	1000
PCI2812S-US	3/8"	1000
PCI2816S-US	1/2"	500

## Tube OD - Inch Series

Gray Acetal Collet - Gray Acetal Body - Nitrile O-ring



Part Number	Tube OD	Box Qty
PM2804S-US	5/32"	1000
PI2806S-US	3/16"	1000
PI2808S-US	1/4"	1000
PM2808S-US	5/16"	1000
PI2812S-US	3/8"	1000
PI2816S-US	1/2"	500

## Tube OD - Inch Series

White Acetal Collet - White Acetal Body - Nitrile O-ring



Part Number	Tube OD	Box Qty
PI2808W-US	1/4"	1000
PM2808W-US	5/16"	1000
PI2812W-US	3/8"	1000

## Tube OD - Inch Series

Black Polypropylene Collet - Black Polypropylene Body - EPDM O-ring



Part Number	Tube OD	Box Qty
PP2808E-US	1/4"	1000
PP2812E-US	3/8"	1000

## Tube OD - Inch Series

White Polypropylene Collet - White Polypropylene Body - EPDM O-ring



Part Number	Tube OD	Box Qty
PP2808W-US	1/4"	1000
PP2812W-US	3/8"	1000

# Fluid Systems Half Cartridges Plastic Tube OD & CTS

## Half Cartridge Kit - Tube OD - Inch Series

Gray Acetal Collet - Gray Acetal Body



Part Number	Tube OD	Box Qty
NC2007-02S-US	1/4"	1000
NC2007-03S-US	5/16"	1000
NC2007-04S-US	3/8"	1000

## Tube OD - Metric Series

Black Acetal Collet - Black Acetal Body - Nitrile O-ring



Part Number	Tube OD	Box Qty
PM2804E-US	4mm	1000
PM2805E-US	5mm	1000
PM2806E-US	6mm	1000
PM2808E-US	8mm	1000
PM2810E-US	10mm	1000
PM2812E-US	12mm	500

## CTS Size - Inch Series

White Collet - White Body - Washer - EPDM O-ring



Part Number	CTS	Box Qty
PCI2820-US	1/2"	200
PCI2828-US	3/4"	100

CTS size Plastic Half Cartridges have also been designed for use in plumbing, recreational vehicle and marine applications.

CTS half cartridges incorporate a spacer and an O-ring.

# Fluid System Half Cartridges Metal Tube OD & CTS

Metal Half Cartridges are designed with the same JG push-fit technology as our Plastic Half Cartridges. As with Plastic Half Cartridges, Metal Half Cartridges are designed to provide a simple, cost-effective method of securing tubing into taps, manifolds, flow direction splitters and many other types of components, which can be produced in a wide variety of metals.

Metal Half Cartridges consist of three components: a collet or gripper, an O-ring of food grade materials and a metal body. Customers should make sure cartridges are suitable for their applications, materials and operating conditions.

**For Half Cartridges with double O-rings, please contact customer service.**

**For additional information, consult our technical support department.**

## Tube OD - Inch Series White/Gray Acetal Collet - Brass Body - EPDM O-ring

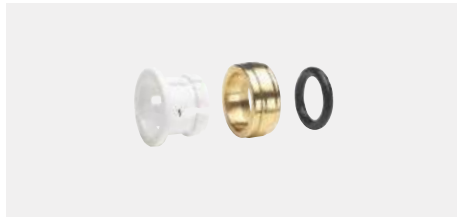

Part Number	Tube OD	Box Qty
CI2812N-US	3/8"	1000
CI2820N	5/8"	1000

White Acetal Collet on 1/4"  
Gray Acetal Collet on 3/8" and 5/8"

## Tube OD - Inch Series Gray Acetal Collet - Brass Body - Nitrile O-ring



Part Number	Tube OD	Box Qty
MM2804N-US	5/32"	1000
MI2806N-US	3/16"	1000
MI2808N-US	1/4"	1000
MM2808N-US	5/16"	1000
MI2812N-US	3/8"	1000
MI2816N-US	1/2"	500

## Tube OD - Inch Series Gray Acetal Collet - Stainless Steel Body - Nitrile O-ring



Part Number	Tube OD	Box Qty
MI2808ST-US	1/4"	1000
MM2808ST-US	5/16"	1000
MI2812ST-US	3/8"	1000

## Tube OD - Metric Series Gray Acetal Collet - Brass Body - EPDM O-ring



Part Number	Tube OD	Box Qty
CM2815N-US	15mm	300

## Tube OD - Metric Series Black/Gray Acetal Collet - Brass Body - Nitrile O-ring



Part Number	Tube OD	Box Qty
MM2804N-US	4mm	1000
MM2805N	5mm	1000
MM2806N-US	6mm	1000
MM2808N-US	8mm	1000
MM2810N-US	10mm	1000

Black Acetal Collet on 5mm, 6mm, 10mm and 12mm  
Gray Acetal Collet on 4mm and 8mm

## CTS Size - Inch Series White Collet - Brass Body - Washer - EPDM O-ring



Part Number	CTS	Box Qty
MWI2820	1/2"	250
MWI2828	3/4"	100
MWI2836	1"	100

CTS size Metal Half Cartridges have also been designed for use in plumbing, recreational vehicle and marine applications.

CTS half cartridges incorporate a spacer and an O-ring.

# Cartridge assembly

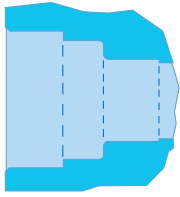

**Step 1**  
Make sure that the cavity is clean and free of debris, burrs or score marks.

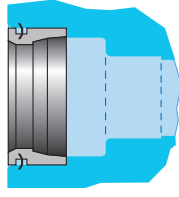

**Step 2**  
Insert the cartridge down into the housing; make sure cartridge is flush with the housing.

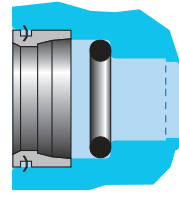

**Step 3**  
Insert the O-ring.

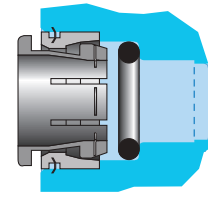

**Step 4**  
Insert collet to complete assembly.

## Dimensions

### Inch

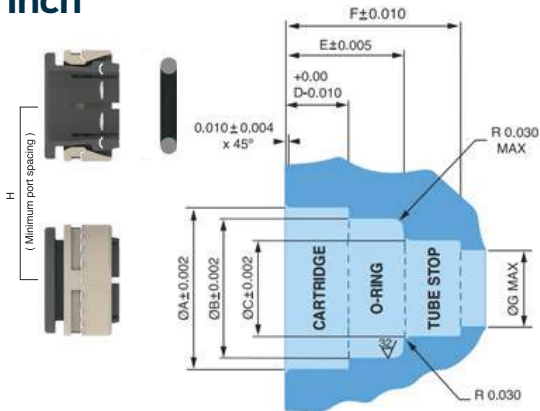

### Metric

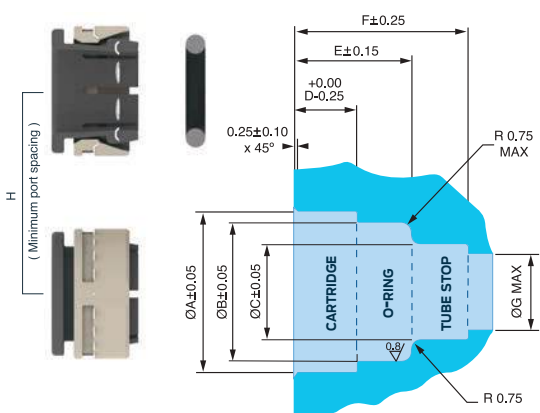

## Details

### Cavity Dimensional Detail (Inch)

Tube OD	ØA	ØB	ØC	D	E1	E2	F1	F2	ØG	H
5/32"*	0.492"	0.327"	0.163"	0.193"	0.350"	0.445"	0.504"	0.598"	0.130"	0.590"
5/32"**	0.472"	0.327"	0.163"	0.193"	0.350"	0.445"	0.504"	0.598"	0.130"	0.590"
3/16"	0.472"	0.348"	0.193"	0.193"	0.340"	0.440"	0.490"	0.590"	0.160"	0.590"
1/4"	0.528"	0.424"	0.255"	0.181"	0.386"	0.480"	0.555"	0.650"	0.230"	0.670"
5/16"	0.544"	0.470"	0.320"	0.215"	0.400"	0.500"	0.590"	0.690"	0.290"	0.670"
3/8"	0.632"	0.547"	0.380"	0.270"	0.465"	0.565"	0.720"	0.815"	0.350"	0.790"
1/2"	0.777"	0.671"	0.506"	0.304"	0.561"	0.659"	0.797"	0.896"	0.480"	0.930"
5/8"	0.935"	0.836"	0.638"	0.335"	0.703"	-	1.093"	-	0.500"	1.060"

\* Metal Half Cartridge  
\*\* Plastic Half Cartridges

E1 and F1 relate to one O-ring  
E2 and F2 relate to two O-rings

### Cavity Dimensional Detail (CTS)

CTS Size	ØA	ØB	ØC	D	E1	E2	F1	F2	ØG	H
1/2" CTS*	0.935"	0.836"	0.638"	0.335"	0.693"	-	1.057"	-	0.546"	1.060"
1/2" CTS**	0.967"	0.836"	0.638"	0.392"	0.693"	-	1.057"	-	0.546"	1.060"
3/4" CTS*	1.222"	1.102"	0.886"	0.427"	0.831"	-	1.362"	-	0.776"	1.358"
3/4" CTS**	1.222"	1.102"	0.886"	0.447"	0.831"	-	1.362"	-	0.776"	1.358"
1" CTS*	1.480"	1.398"	1.141"	0.429"	0.791"	-	1.386"	-	1.003"	1.628"

\* Metal Half Cartridge  
\*\* Plastic Half Cartridges

E1 and F1 relate to one O-ring  
E2 and F2 relate to two O-rings

### Cavity Dimensional Detail (Metric)

Tube OD	ØA	ØB	ØC	D	E1	E2	F1	F2	ØG	H
4mm*	12.50mm	8.30mm	4.14mm	4.90mm	8.90mm	11.30mm	12.80mm	15.20mm	3.30mm	15.0mm
4mm**	11.98mm	8.30mm	4.14mm	4.90mm	8.90mm	11.30mm	12.80mm	15.20mm	3.30mm	15.0mm
5mm	11.98mm	9.06mm	5.13mm	4.90mm	8.63mm	11.17mm	12.44mm	14.98mm	4.30mm	15.0mm
6mm	13.41mm	10.00mm	6.12mm	4.60mm	9.80mm	12.20mm	14.00mm	16.50mm	5.30mm	16.5mm
8mm	13.82mm	11.94mm	8.13mm	5.46mm	10.15mm	12.70mm	15.00mm	17.50mm	7.40mm	17.0mm
10mm	16.05mm	14.00mm	10.15mm	6.86mm	11.81mm	14.35mm	18.17mm	20.71mm	9.20mm	19.0mm
12mm*	19.10mm	16.54mm	12.15mm	8.65mm	15.50mm	19.00mm	23.50mm	27.00mm	11.20mm	22.0mm
12mm*	19.74mm	16.54mm	12.15mm	7.72mm	15.90mm	-	23.90mm	-	11.20mm	24.0mm
15mm	22.86mm	20.32mm	15.19mm	9.50mm	17.50mm	21.00mm	26.90mm	30.40mm	14.20mm	27.0mm
22mm	31.05mm	27.80mm	22.20mm	10.85mm	21.10mm	24.70mm	31.60mm	35.20mm	21.20mm	34.5mm

\* Metal Half Cartridge  
\*\* Plastic Half Cartridges

E1 and F1 relate to one O-ring  
E2 and F2 relate to two O-rings

# Fluid System Kits Service & Repair

Service and Repair Kits include various configurations of our most popular fittings in 1/4", 3/8" and 1/2" OD sizes within the Polypropylene Range. Fittings come in a sturdy and compartmentalized case for ease of storage and transportation.

## Working pressures and temperatures

Water Max. 150 psi at 70 °F (Max. 10 bar at 20 °C)  
 Max. 60 psi at 140 °F (Max. 4 bar at 60 °C)  
 Min. 33 °F/1 °C

**NOT suitable for compressed air applications. For these situations, we recommend the PI Range on pages 19-26.**

For technical specifications, refer to page 76.



### Service & Repair Kit White Polypropylene



#### Service and repair kits include the following:

Part Number	Description	Qty
<b>KIT-ISRKE</b>		
<b>KIT INCLUDES</b>		
PP010822W-US	1/4" x 1/4" Male Connector	5
PP011222W-US	3/8" x 1/4" Male Connector	5
PP011223W-US	3/8" x 3/8" Male Connector	5
PP0208W-US	1/4" Union Tee	5
PP0212W-US	3/8" Union Tee	5
PP0308W-US	1/4" Union Elbow	5
PP0312W-US	3/8" Union Elbow	5
PP0408W-US	1/4" Union Connector	5
PP0412W-US	3/8" Union Connector	5
PP061208W-US	3/8" x 1/4" Reducer	5
PP201208W	3/8" x 1/4" Reducing Union Connector	5
PP220808W-US	1/4" x 1/4" Plug In Elbow	5
PP221212W-US	3/8" x 3/8" Plug In Elbow	5
PP3208U7W-US	1/4" Faucet Connector UNS Thread	5
PP3212U7W-US	3/8" Faucet Connector UNS Thread	5
PP480822W-US	1/4" x 1/4" NPTF Fixed Elbow	5
PP481223W-US	3/8" x 3/8" NPTF Fixed Elbow	5
PPSV040808WP	1/4" Straight Shut-Off Valve	3
ASVPPILF	3/8" x 3/8" x 1/4" Angle Stop Valve	2
ASVPP5LF-US	1/2" x 3/8" x 1/4" Angle Stop Valve	1
TSNIP-US	Tube Cutter	1

### Service & Repair Kit Black Polypropylene - UV Stabilized



#### Service and repair kits include the following:

Part Number	Description	Qty
<b>KIT-ISRKE</b>		
<b>KIT INCLUDES</b>		
PP010822E-US	1/4" x 1/4" Male Connector	5
PP010823E-US	1/4" x 3/8" Male Connector	5
PP011222E-US	3/8" x 1/4" Male Connector	5
PP011223E-US	3/8" x 3/8" Male Connector	5
PP0208E-US	1/4" Union Tee	5
PP0212E-US	3/8" Union Tee	5
PP0308E-US	1/4" Union Elbow	5
PP0312E-US	3/8" Union Elbow	5
PP0408E-US	1/4" Union Connector	5
PP0412E-US	3/8" Union Connector	5
PP050822E-US	1/4" x 1/4" Stem Adapter	5
PP051223E-US	3/8" x 3/8" Stem Adapter	5
PP201208E-US	3/8" x 1/4" Reducing Union Connector	5
PP201612E-US	1/2" x 3/8" Reducing Union Connector	5
PP220808E-US	1/4" x 1/4" Plug In Elbow	5
PP221212E-US	3/8" x 3/8" Plug In Elbow	5
PP450822E-US	1/4" x 1/4" NPTF Female Adapter	5
PP480822E-US	1/4" x 1/4" NPTF Fixed Elbow	5
PP481222E-US	3/8" x 1/4" NPTF Fixed Elbow	5
PP481223E-US	3/8" x 3/8" NPTF Fixed Elbow	5
TSNIP-US	Tube Cutter	1

### Appliance Service & Repair Kit



#### Service and repair kits include the following:

Part Number	Description	Qty
<b>KIT-ISRKA</b>		
<b>KIT INCLUDES</b>		
1/4SCV-US	1/4" Check Valve	2
3/8SCV-US	3/8" Check Valve	2
ASVPP5LF-US	1/2" x 3/8" x 1/4" Angle Stop Valve	1
ASVPP6LF-US	1/2" x 3/8" x 3/8" Angle Stop Valve	1
CI530808W	1/4" Stackable Tee	2
NC2099P	5/16" x 1/4" Reducing Union Connector	5
NC2723-US	3/8" OD Female Swivel Elbow	2
PP0308W-US	1/4" Union Elbow	5
PPM0308W-US	5/16" Union Elbow	5
PP0312W-US	3/8" Union Elbow	5
PP0408W-US	1/4" Union Connector	5
PPM0408W-US	5/16" Union Connector	5
PP0412W-US	3/8" Union Connector	5
PP0808W-US	1/4" Plug	5
PPM0808W-US	5/16" Plug	5
PP0812W-US	3/8" Plug	5
PP201208W	3/8" x 1/4" Reducing Union Connector	5
PP211008W-US	5/16" x 1/4" Reducing Elbow	5
PP211208W-US	3/8" x 1/4" Reducing Elbow	5
PP3208U7W-US	1/4" Faucet Connector UNS Thread	5
PPSV040808W-US	1/4" Straight Shut-Off Valve	1
PPSV041212W-US	3/8" Straight Shut-Off Valve	1
PPSV451223W	3/8" x 3/8" NPTF Female Shut-Off Valve	1
PSEI6012U9-US	3/8" Female Connector UNEF Thread	2
TSNIP-US	Tube Cutter	1

# Fluid System Kits

## Ice Maker/Water Supply

Ice Maker and Water Supply Kits include (25 ft.) of 1/4" LLDPE Tubing, (1) 1/4" OD Angle Stop Adapter Valve and (1) 1/4" OD Faucet Connector. These kits are designed for applications in reverse osmosis, filtration systems, automatic coffee brewers, ice makers and the majority of refrigeration hookups.

**NOT suitable for compressed air applications.**

For general technical specifications, refer to page 76.



### Ice Maker Kit



Part Number  
Ice Maker Kit

### Water Supply Kit



Part Number  
WSK-W  
WSK-B  
- W indicates white tubing  
- B indicates blue tubing

# Fluid System Single Packed: OD Fittings & Valves

The following fluid system fittings and valves are offered in single-packed zip-seal bags for tube sizes 1/4" OD to 1/2" OD. They have been specifically designed for merchandising and distribution benefits. User instructions are noted on the bag and are offered in both English and Spanish.

**NOT suitable for compressed air applications.**

For general technical specifications, refer to page 76.



NSF 51  
NSF 61

## Male Connector NPTF Thread



Part Number	Tube OD	Thread NPTF	Bag Qty
PP010822WP	1/4"	1/4"	1
PP010823WP	1/4"	3/8"	1
PP011222WP	3/8"	1/4"	1
PP011223WP	3/8"	3/8"	1

## Union Tee



Part Number	Tube OD	Bag Qty
PP0208WP	1/4"	1
PP0212WP	3/8"	1

## Union Elbow



Part Number	Tube OD	Bag Qty
PP0308WP	1/4"	1
PP0312WP	3/8"	1

## Union Connector



Part Number	Tube OD	Bag Qty
PP0408WP	1/4"	1
PP0412WP	3/8"	1

## Reducer



Part Number	Stem OD	Tube OD	Bag Qty
PP061208WP	3/8"	1/4"	1

## Reducing Union Connector



Part Number	Tube OD	Tube OD	Bag Qty
PP201008WP	5/16"	1/4"	1
PP201208WP	3/8"	1/4"	1



# Fluid System Single Packed: OD Fittings & Valves

## Reducing Tee



Part Number	Tube OD Ends	Tube OD Branch	Bag Qty	Box Qty
PP30121208WP	3/8"	1/4"	1	150

## Faucet Connector UNS Thread



Part Number	Tube OD	Thread UNS	Bag Qty
PP3208U7WP	1/4"	7/16"-24	1
PP3212U7WP	3/8"	7/16"-24	1

7/16 – 24 UNS = 1/4 Compression Threads

## Female Adapter NPTF Thread



Part Number	Tube OD	Thread NPTF	Bag Qty
PP450822WP	1/4"	1/4"	1
PP451222WP	3/8"	1/4"	1

## End Cap



Part Number	Tube OD	Bag Qty
PP4608WP	1/4"	1

## Fixed Elbow NPTF Thread



Part Number	Tube OD	Thread NPTF	Bag Qty
PP481623WP	1/2"	3/8"	1

## Angle Stop Adapter Valve



Part Number	Size	Bag Qty
ASVPP1LF-US	3/8" x 3/8" x 1/4"	1
ASVPP2LF-US	3/8" x 3/8" x 3/8"	1

Male Comp. x Female Comp. x Tube OD

## Angle Stop Adapter Valve Conversion Thread



Part Number	Size	Bag Qty
ASVPP5LF-US	3/8" x 3/8" x 1/4"	1
ASVPP6LF-US	3/8" x 3/8" x 3/8"	1

Male/Female NPS x Comp. x Tube OD

## Shut-Off Valve (Male) Speedfit to Male (NPTF Thread)



Part Number	Tube OD	Thread NPTF	Bag Qty
PPSV010822WP	1/4"	1/4"	1
PPSV011223WP	3/8"	3/8"	1

## Straight Shut-Off Valve Speedfit to Speedfit



Part Number	Tube OD	Bag Qty
PPSV040808WP	1/4"	1
PPSV041212WP	3/8"	1

# Fluid System Single Packed: OD Fittings & Valves

## Shut-Off Valve (Female Elbow) Speedfit to Female (NPTF Thread)



Part Number	Tube OD	Thread NPTF	Bag Qty
PPSV500822WP	1/4"	1/4"	1
PPSV501222WP	3/8"	1/4"	1

## Reducing Union Connector



Part Number	Tube OD	Tube OD	Bag Qty	Box Qty
NC2099-US	5/16"	1/4"	100	400

## Union Connector



Part Number	Tube OD	Bag Qty	Box Qty
NC2112P	5/16"	1	500

## Ice Maker/Water Supply Kits



Part Number	Bag Qty	Box Qty
Ice Maker Kit	1	12
WSK-B	1	12
WSK-W	1	12

Includes: (25 ft.) of 1/4" LLDPE Tubing, (1) 1/4" OD Angle Stop Adapter Valve and (1) 1/4" OD Faucet Connector

-B indicates blue tubing  
-W indicates white tubing

## LLDPE Tubing (25' Coils)



Part Number	Tube OD	Coil Lengths	Bag Qty	Box Qty
PE-08-BI-025F-B	1/4"	25'	1	20
PE-08-BI-025F-N	1/4"	25'	1	20
PE-08-BI-025F-E	1/4"	25'	1	20
PE-12-EI-025F-B	3/8"	25'	1	12
PE-12-EI-025F-N	3/8"	25'	1	12

Suffix indicates color

B = Blue

N = Natural

E = Black

# ProLock™ Products

## Finish jobs faster

Our ProLock Range has been designed with an audible click and visible alignment arrows to assure installers that a fitting is secure. Fittings are ideal for use in water softener/conditioner systems and virtually any OEM type of application involving joining solutions.

ProLock fittings have a collet with stainless steel teeth that grip the pipe when fully inserted, and an O-ring to provide a permanent, leak-proof seal.

When twisted into place, the locking cap locks the pipe in place securely. No special tools, soldering, clamps or glue are ever required. Fittings reduce installation times by more than 40% and are code-approved for behind-the-wall use.



# How to make a ProLock™ connection

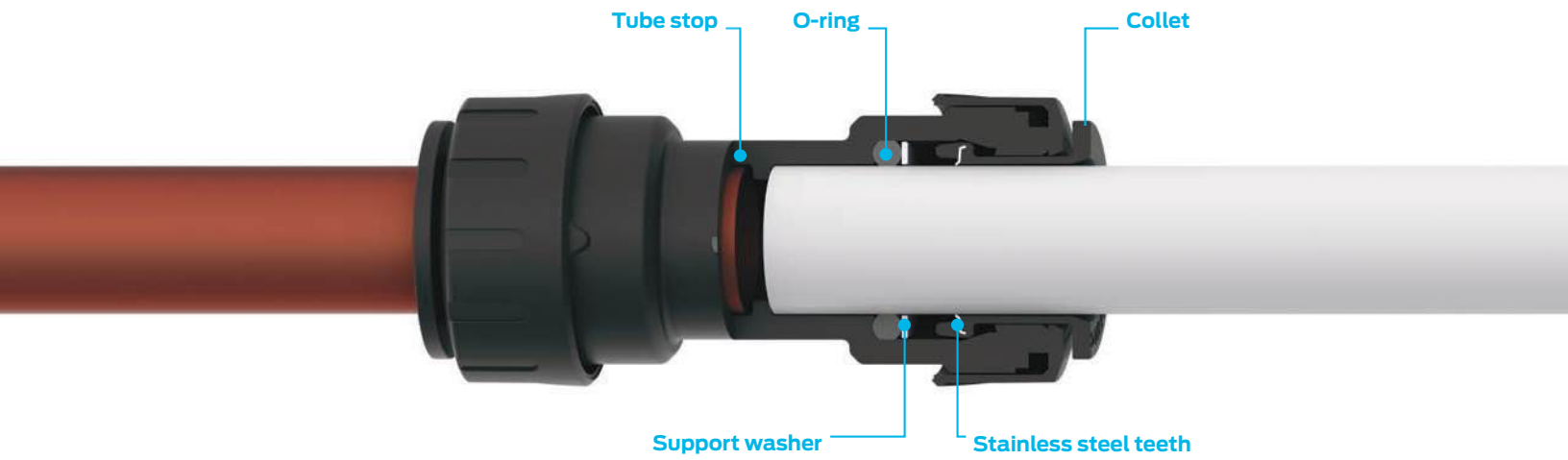

## To connect

Keep product clean until ready to use. Always pressure test before use.



### Step 1

Cut the pipe square using a copper pipe cutter. Remove all burrs and sharp edges.

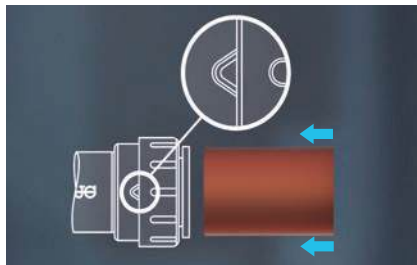

### Step 2

Insert pipe fully into fitting.

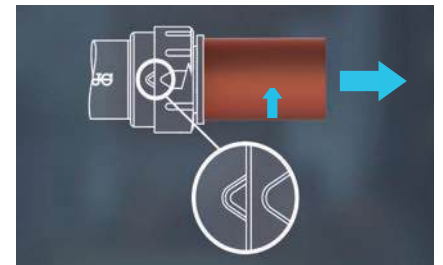

### Step 3

Turn locking cap quarter turn clockwise to locked position. Once locked, there will be an audible click and indicator marks will be in alignment.

## To disconnect

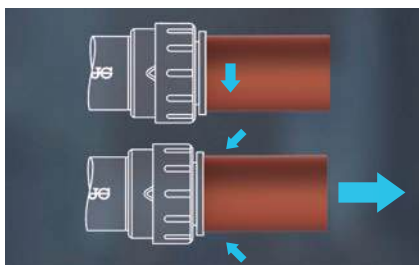

### Step 1

Depressurize the system. Turn locking cap quarter turn counter clockwise. Depress collet against the fitting and remove pipe.

# ProLock™ Fittings Black CTS

The PSEI Range of ProLock fittings is offered in 3/8" to 1" CTS sizes. These fittings are manufactured from high-quality engineered plastic with EPDM O-rings, are UV stabilized for outdoor use and are suitable for hot and cold water plumbing applications.

## Working pressures and temperatures

Water Max. 160 psi at 73 °F  
 Max. 100 psi at 180 °F  
 Max. 80 psi at 200 °F

For use with Copper, PEX and CPVC Pipe.

For technical specifications, refer to page 77.



NSF 61

UPMO UNIFORM PLUMBING CODE

## Male Connector NPT Thread



Part Number	Size CTS x NPT	Bag Qty	Box Qty
PSEI011624E	3/8" x 1/2"	10	100
PSEI012024E	1/2" x 1/2"	10	80
PSEI012026E	1/2" x 3/4"	5	60
PSEI012824E	3/4" x 1/2"	5	50
PSEI012826E	3/4" x 3/4"	5	50
PSEI012828E	3/4" x 1"	5	30
PSEI013626E	1" x 3/4"	2	30
PSEI013628E	1" x 1"	2	20

Only to be used with plastic mating threads

## Tee



Part Number	Size CTS	Bag Qty	Box Qty
PSEI0216E	3/8"	5	50
PSEI0220E	1/2"	5	30
PSEI0228E	3/4"	5	15
PSEI0236E	1"	1	10

## Elbow



Part Number	Size CTS	Bag Qty	Box Qty
PSEI0316E	3/8"	10	80
PSEI0320E	1/2"	10	50
PSEI0328E	3/4"	5	30
PSEI0336E	1"	5	15

## Coupler



Part Number	Size CTS	Bag Qty	Box Qty
PSEI0416E	3/8"	10	80
PSEI0420E	1/2"	10	50
PSEI0428E	3/4"	5	30
PSEI0436E	1"	5	20

## Male Stem Adapter NPT Thread



Part Number	Size Stem x NPT	Bag Qty	Box Qty
PSEI052826E	3/4" x 3/4"	10	60
PSEI053628E	1" x 1"	10	40

Only to be used with plastic mating threads

## Reducer



Part Number	Size Stem x CTS	Bag Qty	Box Qty
PSEI062016E	1/2" x 3/8"	10	100
PSEI062820E	3/4" x 1/2"	10	80
PSEI063628E	1" x 3/4"	5	40

# ProLock™ Fittings Black CTS

## Reducing Coupler



Part Number	Size CTS	Bag Qty	Box Qty
PSEI202016E	1/2" x 3/8"	10	80
PSEI202820E	3/4" x 1/2"	5	40
PSEI203628E	1" x 3/4"	5	20

## Reducing Elbow



Part Number	Size CTS	Bag Qty	Box Qty
PSEI212016E	1/2" x 3/8"	10	60
PSEI212820E	3/4" x 1/2"	5	40
PSEI213628E	1" x 3/4"	5	20

## Plug In Elbow



Part Number	Size Stem x CTS	Bag Qty	Box Qty
PSEI222020E	1/2" x 1/2"	10	80
PSEI222828E	3/4" x 3/4"	5	40
PSEI223636E	1" x 1"	5	20

## Reducing Tee



Part Number	Size CTS	Bag Qty	Box Qty
PSEI3016AE	1/2" x 1/2" x 3/8"	5	40
PSEI3028AE	3/4" x 3/4" x 1/2"	5	20
PSEI3028BE	3/4" x 1/2" x 1/2"	5	20
PSEI3028CE	1/2" x 1/2" x 3/4"	5	20
PSEI3028DE	3/4" x 1/2" x 3/4"	5	20
PSEI3036AE	1" x 1" x 3/4"	1	10

## End Cap



Part Number	Size CTS	Bag Qty	Box Qty
PSEI4616E	3/8"	10	200
PSEI4620E	1/2"	10	150
PSEI4628E	3/4"	5	80
PSEI4636E	1"	5	40

## Male Fixed Elbow NPT Thread



Part Number	Size CTS x NPT	Bag Qty	Box Qty
PSEI482024E	1/2" x 1/2"	5	60

**Only to be used with plastic mating threads**

## Female Stem Adapter NPS Thread



Part Number	Size Stem x NPS	Bag Qty	Box Qty
PSEI502034E	1/2" x 1/2"	10	100

## Stackable Tee



Part Number	Size CTS	Bag Qty	Box Qty
PSEI532020E	1/2" x 1/2" x 1/2"	5	40
PSEI532820E	3/4" x 3/4" x 1/2"	5	25
PSEI532828E	3/4" x 3/4" x 3/4"	5	20
PSEI533628E	1" x 1" x 3/4"	1	10

## Stackable Tee Details



# ProLock™ Fittings Black CTS

## Female Connector NPS Thread



Part Number	Size CTS x NPS	Bag Qty	Box Qty
PSEI622036E-L	1/2" x 3/4"	2	150
PSEI622836E-L	3/4" x 3/4"	2	150
PSEI622838E-L	3/4" x 1"	2	150
PSEI623638E-L	1" x 1"	2	100
PSEI62363AE-L	1" x 1 1/4"	1	75

## Female Elbow Connector NPS Thread



Part Number	Size CTS x NPS	Bag Qty	Box Qty
PSEI632836E-L	3/4" x 3/4"	2	150
PSEI632838E-L	3/4" x 1"	2	100
PSEI63283AE-L	3/4" x 1 1/4"	1	75
PSEI63363AE-L	1" x 1 1/4"	1	75

## Shut-Off Valve



Part Number	Size CTS	Bag Qty	Box Qty
PSEISV20EP	1/2"	1	100
PSEISV28EP	3/4"	1	75

Includes 2 interchangeable buttons for color coding hot & cold water.

## Slip Connector Burst Pipe Repair Fitting



Part Number	Size CTS	Bag Qty	Box Qty
1/2SCEP	1/2"	1	125
3/4SCEP	3/4"	1	75

A quick and easy method of replacing burst or damaged pipe without the need to alter existing pipe work.

## Female Garden Hose Elbow NH Thread



Part Number	Size OD x NH	Bag Qty	Box Qty
NC2723-US	3/8" x 3/4"-11.5	5	400

# Flexi Hose

## Working pressures and temperatures

Water Max. 125 psi, Min. 20 psi  
Max. 160 °F, Min. 40 °F

## Flexi Hose - 18" Length NPS Thread



Part Number	Size CTS x NPS	Bag Qty	Box Qty
PSFC20N3618E	1/2" x 3/4"	1	40
PSFC28N3618E	3/4" x 3/4"	1	40

## Flexi Hose - 18" Length



Part Number	Size CTS x CTS	Bag Qty	Box Qty
PSFC28C2818E	3/4" x 3/4"	1	40



# ProLock™ Fittings Brass CTS

## Male Connector NPT Thread



Part Number	Size CTS x NPT	Bag Qty	Box Qty
MWI011624LF-E	3/8" x 1/2"	10	100
MWI012024LF-E	1/2" x 1/2"	10	100
MWI012026LF-E	1/2" x 3/4"	10	100
MWI012824LF-E	3/4" x 1/2"	5	50
MWI012826LF-E	3/4" x 3/4"	5	50
MWI012828LF-E	3/4" x 1"	5	50
MWI013626LF-E	1" x 3/4"	1	25
MWI013628LF-E	1" x 1"	1	25

## Male Stem Adapter



Part Number	Size CTS x NPT	Bag Qty	Box Qty
MWI052024LF	1/2" 1/2"	10	100
MWI052826LF	3/4" 3/4"	5	50

## Female Connector NPS Thread



Part Number	Size CTS x NPS	Bag Qty	Box Qty
PSEI601634E	3/8" x 1/2"	10	100
PSEI602034E	1/2" x 1/2"	10	80
PSEI602036E	1/2" x 3/4"	5	50
PSEI602834E	3/4" x 1/2"	5	30
PSEI602836E	3/4" x 3/4"	5	30
PSEI603638E	1" x 1"	5	25

## Female Elbow Connector NPS Thread



Part Number	Size CTS x NPS	Bag Qty	Box Qty
PSEI612034E	1/2" x 1/2"	5	50
PSEI612836E	3/4" x 3/4"	5	30

## Wing Back Elbow



Part Number	Size CTS x NPS	Bag Qty	Box Qty
WBI2024E	1/2" x 1/2"	1	20

**Not for potable water applications.**

# Speedfit™ Products

## Fitting the future

Complete installations in no time with our wide range of Speedfit fittings, valves and piping solutions. The CTS Range of fittings offer all that's needed to create a high-performance and aesthetically appealing system without the need for any special tools. Incorporating advanced gripping technology, our connection system creates a durable, leak-proof seal.

When locked into place, the advanced Twist & Lock™ range adds further compression and our pipe inserts provide an additional multi-seal.



# How to make a Twist & Lock™ connection

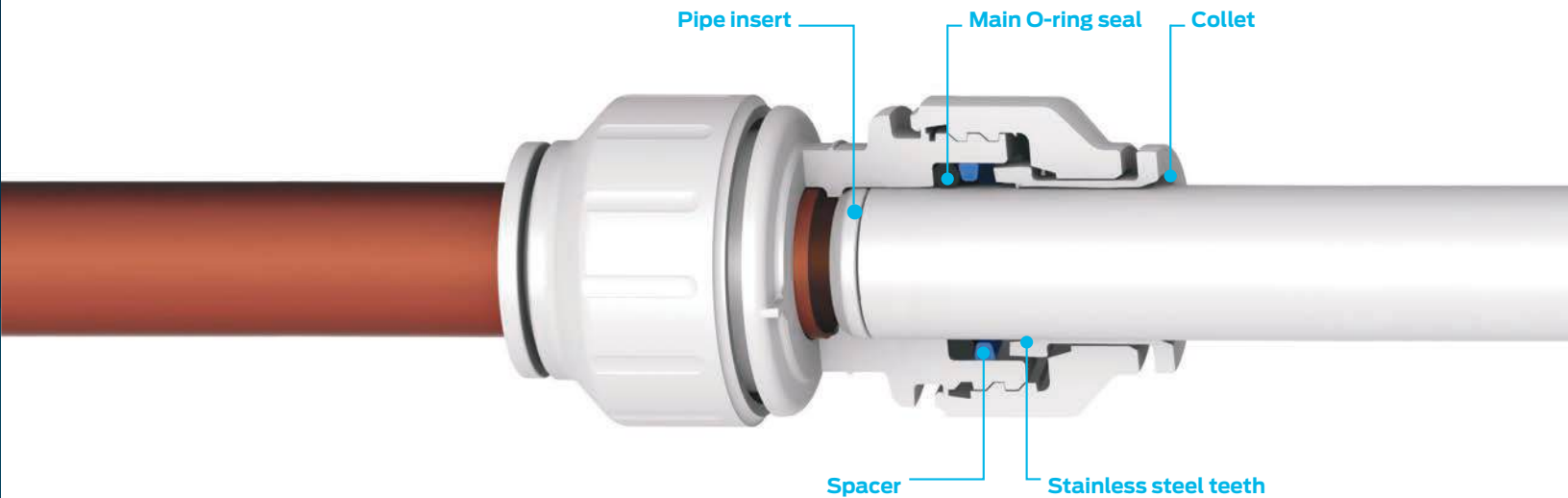

## To connect

Keep product clean until ready to use. Always pressure test before use.

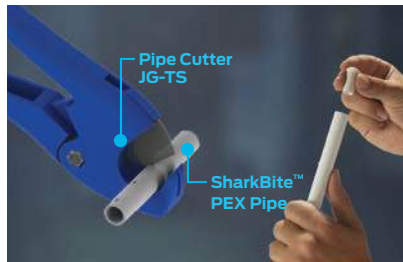

### Step 1

To prevent damage to the O-ring, remove all burrs and sharp edges. When using SharkBite™ PEX or other types of PEX Pipe, we recommend the use of a Pipe Insert.

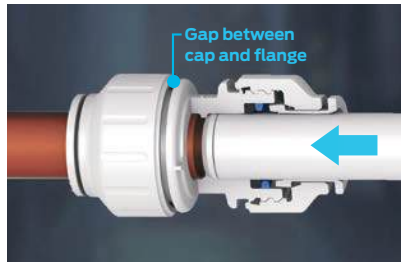

### Step 2

The fitting should be in the unlocked position. This is shown by a small gap between the screw-cap and the body flange. Push the pipe into the fitting and up to the pipe stop.

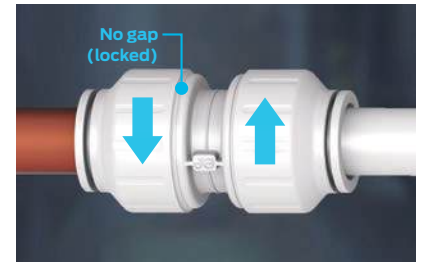

### Step 3

Twist the screw-cap until it touches the body flange. This locks the pipe into position and increases the o-ring seal around the pipe. Pull to check that it is secure. It is a good practice to test the system prior to leaving the site or before use. Our recommended test procedure is shown in our Technical Checklist.

## To disconnect



### Step 1

Make sure that the system is depressurized. Be sure to twist the screw-cap back to the unlocked position.

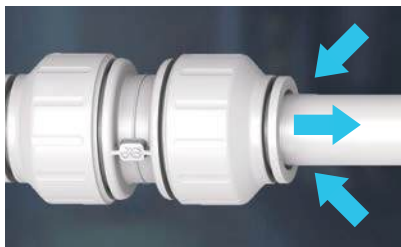

### Step 2

Push the collet square against the face of the fitting. With collet held in position, the pipe can be removed. The fitting can be used again without additional replacement parts.

## What not to do

- Do not use damaged or scored pipe
- Do not use a hacksaw to cut the pipe
- Do not leave burrs on the end of the pipe
- Do not forget to push the pipe fully into the fitting, past both the collet (gripper) and the O-ring.
- Do not insert fingers into the fitting as the stainless steel teeth may cause injury.

# Twist & Lock™ Fittings White CTS

The PEI Range of Twist & Lock Fittings is offered in 3/8" to 1" CTS sizes. These fittings are manufactured from high-quality engineered plastic with EPDM O-Rings. Speedfit fittings are suitable for hot and cold water plumbing applications.

## Working pressures and temperatures

Water Max. 160 psi at 73°F  
 Max. 100 psi at 180°F  
 Max. 80 psi at 200°F

For use with Copper, PEX and CPVC Pipe.

For technical specifications, refer to page 78.



### Male Connector NPT Thread



Part Number	Size CTS x NPT	Bag Qty	Box Qty
PSEI011624	3/8" x 1/2"	10	100
PSEI012024	1/2" x 1/2"	10	80
PSEI012026	1/2" x 3/4"	5	60
PSEI012826	3/4" x 3/4"	5	50
PSEI013626	1" x 3/4"	2	30
PSEI013628	1" x 1"	2	20

Only to be used with plastic mating threads

### Tee



Part Number	Size CTS	Bag Qty	Box Qty
PSEI0216	3/8"	5	50
PEI0220	1/2"	5	25
PEI0228	3/4"	2	10
PEI0236	1"	1	5

### Elbow



Part Number	Size CTS	Bag Qty	Box Qty
PSEI0316	3/8"	10	80
PEI0320	1/2"	5	40
PEI0328	3/4"	5	20
PEI0336	1"	1	10

### Coupler



Part Number	Size CTS	Bag Qty	Box Qty
PSEI0416	3/8"	10	80
PEI0420	1/2"	5	40
PEI0428	3/4"	5	25
PEI0436	1"	1	15

### Reducer



Part Number	Size Stem x CTS	Bag Qty	Box Qty
PSEI062016	1/2" x 3/8"	10	100
PEI062820	3/4" x 1/2"	10	50
PEI063628	1" x 3/4"	5	30

### Reducing Coupler



Part Number	Size CTS	Bag Qty	Box Qty
PSEI202016	1/2" x 3/8"	10	80
PEI202820	3/4" x 1/2"	5	30
PEI203628	1" x 3/4"	5	15
PSEI202008	1/2" x 1/4" OD	10	80
PSEI202012	1/2" x 3/8" OD	10	80

# Twist & Lock™ Fittings White CTS

## Reducing Elbow



Part Number	Size CTS	Bag Qty	Box Qty
PEI212820	3/4" x 1/2"	5	25
PEI213628	1" x 3/4"	1	10

## Plug In Elbow



Part Number	Size Stem x CTS	Bag Qty	Box Qty
PEI222020	1/2" x 1/2"	10	60
PEI222828	3/4" x 3/4"	5	25

## Reducing Tee NPT Thread



Part Number	Size CTS	Bag Qty	Box Qty
PEI3028A	3/4" x 3/4" x 1/2"	5	15
PEI3028B	3/4" x 1/2" x 1/2"	5	20
PEI3028C	1/2" x 1/2" x 3/4"	5	20
PEI3028D	3/4" x 1/2" x 3/4"	5	15
PEI3036A	1" x 1" x 3/4"	1	10

## Female Connector - Brass Nut NPS Thread



Part Number	Size CTS x NPS	Bag Qty	Box Qty
PEI452034	1/2" x 1/2"	5	50
PSEI452826	3/4" x 3/4"	5	40

## End Cap



Part Number	Size CTS	Bag Qty	Box Qty
PSEI4620	1/2"	10	150
PSEI4620B	1/2"	10	150
PSEI4620R	1/2"	10	150
PSEI4628	3/4"	5	80
PSEI4628B	3/4"	5	80
PSEI4628R	3/4"	5	80
PSEI4636	1"	5	40

Suffix B denotes blue  
Suffix R denotes red

## Male Fixed Elbow NPT Thread



Part Number	Size CTS x NPT	Bag Qty	Box Qty
PSEI482024	1/2" x 1/2"	5	60

Only to be used with plastic mating threads

## Stackable Tee



Part Number	Size CTS	Bag Qty	Box Qty
PEI532020	1/2" x 1/2" x 1/2"	5	30
PEI532820	3/4" x 3/4" x 1/2"	5	20
PEI532828	3/4" x 3/4" x 3/4"	1	15

## Stackable Tee



Ideal for multi-port manifold

Sizes for Stackable Tee are listed in the following order

## Female Connector UNEF Thread



Part Number	Size OD x UNEF	Bag Qty	Box Qty
PSEI6012U9-US	3/8" x 9/16"-24	10	200

9/16-24 UNEF = 3/8 Compression Threads

# Twist & Lock™ Fittings White CTS

## Female Swivel Elbow NPS Thread



Part Number	Size CTS x NPS	Bag Qty	Box Qty
PEIBTC2034	1/2" x 1/2"	10	50

Hand tighten only, no spanner required

## Female Ballcock Elbow UNS Thread



Part Number	Size CTS x UNS	Bag Qty	Box Qty
PEIBTC20C75	1/2" x 7/8"	10	50

Connects to toilet fill valve  
Hand tighten only, no spanner required

## Female Swivel Connector NPS Thread



Part Number	Size CTS x NPS	Bag Qty	Box Qty
PEISTC2034	1/2" x 1/2"	10	50

Hand tighten only, no spanner required

## Female Ballcock Connector UNS Thread



Part Number	Size CTS x UNS	Bag Qty	Box Qty
PEISTC20C75	1/2" x 7/8"	10	50

Connects to toilet fill valve  
Hand tighten only, no spanner required

## Shut-Off Valve



Part Number	Size CTS	Bag Qty	Box Qty
PSEISV20P	1/2"	1	100
PSEISV28P	3/4"	1	75

Includes 2 interchangeable buttons for color coding hot & cold water.

## Slip Connector Burst Pipe Repair Fitting



Part Number	Size CTS	Bag Qty	Box Qty
1/2SCP	1/2"	1	125
3/4SCP	3/4"	1	75

A quick and easy method of replacing burst or damaged pipe without the need to alter existing pipe work.

## Male Connector



Part Number	Size CTS x NPT	Bag Qty	Box Qty
MWI012024LF	1/2" 1/2"	10	100
MWI012026LF	1/2" 3/4"	10	100
MWI012826LF	3/4" 3/4"	5	50

## Male Stem Adapter



Part Number	Size CTS x NPT	Bag Qty	Box Qty
MWI052024LF	1/2" 1/2"	10	100
MWI052826LF	3/4" 3/4"	5	50

## Wing Back Elbow



Part Number	Size CTS x NPT	Bag Qty	Box Qty
WBI2024	1/2" 1/2"	1	20

Not for potable water applications.

# ProLock™ Fittings Black CTS for Water Softener installations

The Black PSEI Range of ProLock Fittings is offered in 3/4" to 1" CTS sizes. They have been specifically designed for Softener Installations/Water Filtration. However, they are also suitable for OEM, Marine and R.V. applications. The fittings are manufactured from high-quality engineered plastic with EPDM O-rings that are UV stabilized for outdoor use and are suitable for hot and cold water applications.

## Working pressures and temperatures

Water Max. 160 psi at 73°F  
 Max. 100 psi at 180°F  
 Max. 80 psi at 200°F



For use with Copper, PEX and CPVC Pipe.

For technical specifications, refer to page 77.

## Tee



Part Number	Size CTS	Bag Qty	Box Qty
PSEI0228E	3/4"	5	15
PSEI0236E	1"	1	10

## Elbow



Part Number	Size CTS	Bag Qty	Box Qty
PSEI0328E	3/4"	5	30
PSEI0336E	1"	5	15

## Coupler



Part Number	Size CTS	Bag Qty	Box Qty
PSEI0428E	3/4"	5	30
PSEI0436E	1"	5	20

## Reducing Coupler



Part Number	Size CTS	Bag Qty	Box Qty
PSEI203628E	1" x 3/4"	5	20

## Plug In Elbow



Part Number	Size Stem x CTS	Bag Qty	Box Qty
PSEI222828E	3/4" x 3/4"	5	40
PSEI223636E	1" x 1"	5	20

## Stem Elbow



Part Number	Size CTS x Stem
*	3/4" x 1 1/4"

## Stem Elbow 1" Size



Part Number	Size CTS x Stem
*	1" x 1 1/4"

## Special Stem Connector



Part Number	Size CTS x Stem
*	3/4" x 1 1/4"

## Stem Connector



Part Number	Size CTS x Stem
*	1" x 1 1/4"

\*Only for Water Softener Applications and available through Clack Distributors

# Single Packed: CTS Fittings & Valves

These CTS fittings are offered in single-packed zip-seal bags for 1/2" to 3/4" CTS sizes. They have been specifically designed for merchandising and distribution benefits. User instructions are noted on the bag and are offered in both English and Spanish. These fittings are suitable for both hot and cold water applications.

For use with Copper, PEX and CPVC Pipe.

For detailed technical specifications, refer to page 78.



## Male Connector NPT Thread



Part Number	Size CTS x NPT	Bag Qty
PSEI012024P	1/2" x 1/2"	1
PSEI012026P	1/2" x 3/4"	1
PSEI012826P	3/4" x 3/4"	1

## Tee



Part Number	Size CTS	Bag Qty
PEI0220P	1/2"	1
PEI0228P	3/4"	1

## Elbow



Part Number	Size CTS	Bag Qty
PEI0320P	1/2"	1
PEI0328P	3/4"	1

## Coupler



Part Number	Size CTS	Bag Qty
PEI0420P	1/2"	1
PEI0428P	3/4"	1

## Reducer



Part Number	Size Stem x CTS	Bag Qty
PEI062820P	3/4" x 1/2"	1

## Reducing Coupler



Part Number	Size CTS	Bag Qty
PEI202820P	3/4" x 1/2"	1

## Reducing Elbow



Part Number	Size CTS	Bag Qty
PEI212820P	3/4" x 1/2"	1

## Reducing Tee



Part Number	Size CTS	Bag Qty
PEI3028AP	3/4" x 3/4" x 1/2"	1

## Female Connector - Brass Nut NPS Thread



Part Number	Size CTS x NPS	Bag Qty
PSEI452826P	3/4" x 3/4"	1



# Single Packed: CTS Fittings & Valves

## End Cap



Part Number	Size CTS	Bag Qty
PSEI4620P	1/2"	1
PSEI4628P	3/4"	1

## Male Fixed Elbow NPT Thread



Part Number	Size CTS x NPT	Bag Qty
PSEI482024P	1/2" x 1/2"	1

## Female Connector UNEF Thread



Part Number	Size OD x UNEF	Bag Qty
PSEI6012U9P	3/8" x 9/16"-24	1

**9/16-24 UNEF = 3/8" Compression Threads**

## Female Swivel Elbow NPS Thread



Part Number	Size CTS x NPS	Bag Qty
PEIBTC2034P	1/2" x 1/2"	1

**Hand connect only, no spanner required**

## Female Swivel Connector NPS Thread



Part Number	Size CTS x NPS	Bag Qty
PEISTC2034P	1/2" x 1/2"	1

**Connects to toilet fill valve**

## Shut-Off Valve



Part Number	Size CTS	Bag Qty
PSEISV20P	1/2"	1
*PSEISV20EP	1/2"	1
PSEISV28P	3/4"	1
*PSEISV28EP	3/4"	1

**Two interchangeable buttons for color coding hot and cold water.**  
\*Black Valve is UV stabilized

## Slip Connector Burst Pipe Repair Fitting



Part Number	Size CTS	Bag Qty
1/2SCP	1/2"	1
3/4SCP	3/4"	1

**A quick and easy method of replacing burst or damaged pipe without the need to alter existing pipe work.**

## Female Garden Hose Elbow NH Thread



Part Number	Size OD x NH	Bag Qty
NC2723P	3/8" x 3/4"-11.5	1

## Flexi Hose - 18" Length



Part Number	Size	Bag Qty
PSFC20N3618E	1/2" CTS x 3/4" NPS	1
PSFC28N3618E	3/4" CTS x 3/4" NPS	1
PSFC28C2818E	3/4" CTS x 3/4" CTS	1

# SharkBite™ PEX Pipe

SharkBite PEX pipe is cross-linked polyethylene tubing used for a wide range of applications. Red, white and blue pipe is available in a variety of CTS sizes for both coil and straight lengths. SharkBite PEX Pipe is durable and flexible, and is UV, chlorine and corrosion resistant.



## White PEX Pipe Coil



Part Number	Size CTS	Coil Length	Pack Qty
U855W50	3/8"	50'	1
U855W100	3/8"	100'	1
U860W50W	1/2"	50'	1
U860W100W	1/2"	100'	1
U870W50W	3/4"	50'	1
U870W100W	3/4"	100'	1
U880W100W	1"	100'	1

## Blue PEX Pipe Coil



Part Number	Size CTS	Coil Length	Pack Qty
U860B50W	1/2"	50'	1
U860B100W	1/2"	100'	1
U870B50W	3/4"	50'	1
U870B100W	3/4"	100'	1
U880B100W	1"	100'	1

## Red PEX Pipe Coil



Part Number	Size CTS	Coil Length	Pack Qty
U860R50W	1/2"	50'	1
U860R100W	1/2"	100'	1
U870R50W	3/4"	50'	1
U870R100W	3/4"	100'	1
U880R100W	1"	100'	1

## White PEX Pipe Straight Lengths



Part Number	Size CTS	Straight Length	Pack Qty
U855W10	3/8"	10'	10\$
U860W10	1/2"	10'	10
U870W10	3/4"	10'	10
U880W10	1"	10'	5

## Blue PEX Pipe Straight Lengths



Part Number	Size CTS	Straight Length	Pack Qty
U860B10	1/2"	10'	10
U870B10	3/4"	10'	10
U880B10	1"	10'	5

## Red PEX Pipe Straight Lengths



Part Number	Size CTS	Straight Length	Pack Qty
U860R10	1/2"	10'	10
U870R10	3/4"	10'	10
U880R10	1"	10'	5

# Accessories

## CTS

### Pipe Clips and Spacer

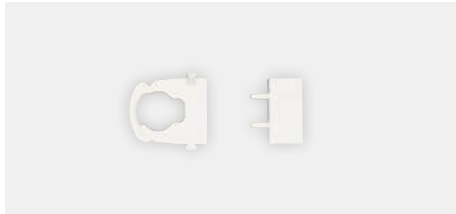

Part Number	Size CTS	Bag Qty	Box Qty
<b>Pipe Clip</b>			
USCLIP20-US	1/2"	50	200
USCLIP28-US	3/4"	50	100
USCLIP36-US	1"	20	80
<b>Pipe Clip Spacer</b>			
PCSW-US	-	50	400

### Nail Clip



Part Number	Size CTS	Bag Qty	Box Qty
NPCI20-US	1/2"	50	400
NPCI28-US	3/4"	50	250

### Pipe Cutter



Part Number	Size CTS	Pack Qty
JG-TS-US	-	1

Suitable for cutting up to 22mm pipe or a 3/4" pipe

### Heavy Duty Pipe Cutter



Part Number	Description	Pack Qty
JG HDC	-	1
BLADE-JGHDC	Blades Only	1

Suitable for cutting up to 28mm pipe or a 1" pipe

### Wrap for Fitting Burial Silicone Wrap



Part Number	Size	Bag Qty
25046	10' x 2" x 0.02"	1

### Pipe Insert



Part Number	Size CTS	Bag Qty	Box Qty
TSI20-US	1/2"	50	500
TSI28-US	3/4"	25	250
TSI36-US	1"	10	150

Not IAPMO Listed

# Technical Specifications

## Fluid System Technical Specifications for Products Listed on Pages 12-59.

### Working Pressure and Temperature Range for Acetal Fittings (PI, SI, SM and PM Range).

		Temp. Pressure	
		Size	Size
		5/32" - 5/16" 4mm - 8mm	3/8" x 1/2" 10mm - 22mm
<b>Air</b>	-4 °F	230psi	150psi
<b>Potable Liquids and Air</b>	+33 °F	230psi	150psi
	+68 °F	230psi	150psi
	+150 °F	150psi	100psi

Also suitable for vacuum

### General Technical Specifications:

For Polypropylene Working Pressure and Temperature Range, refer to the Fluid Systems portion of catalog.

### Tube Types

Plastic Tube - Polyethylene, nylon and polyurethane conforming to the tolerances shown below. For soft tubing or thin wall tube we recommend the use of tube inserts.

Braided Tube - Use of Tube to Hose Stems listed on page 14 is essential when using braided tube or hose. The use of clamps to retain braided tube on barbs is recommended.

Metal Tube (soft) - Brass, copper or mild steel conforming to the tolerances below.

Metal Tube (hard) - We do not recommend John Guest fittings for hard metal or chrome plated tubes.

For stainless steel and other polished metal tubes we recommend the use of Superseal fittings. These are shown on page 30-31 of this catalog.

It is essential that outside diameters be free from score marks and that the tube be deburred before inserting the fitting. John Guest stem fittings are only for use with John Guest fittings.

### Tube Tolerances

John Guest Fluid System fittings are offered for tubes with outside diameters to the following tolerances.

<b>Size (inches)</b>	5/32 - 3/16	1/4 - 1/2
<b>Tolerance (inches)</b>	+0.001 / -0.003	+0.001 / -0.004
<b>Size (mm)</b>	4mm - 5mm	6mm - 22mm
<b>Tolerance (mm)</b>	+0.05 / -0.07	+0.05 / -0.10

### Installation and System Testing

#### Fittings and tube should be kept clean and undamaged before use.

All tube and fittings installations must be pressure tested after installation to ensure system integrity before handing over to the final user. Refer to "How to make a Push-Fit connection".

### Chemicals

For use with chemicals or other potentially aggressive liquids, please contact our Technical Support Department. John Guest fittings are not recommended for use with explosive gases, petroleum spirits, or other fuels.

### Collet Covers

Are available as additional security against removal of the tube or to provide a simple means of color coding.

The cover is offered in a range of six colors. Please see page 46 of this catalog.

### Food Quality

All of the fittings in this catalog are produced in Food and Drug Administration (FDA) approved materials and are therefore recommended for food quality applications.

The wetted surfaces of John Guest PI, PM, SI, SM, CI, CM and NC plastic fittings, PPSV and ASV Valves, and PE Tubing are in compliance with FDA requirements for direct contact with food as detailed in 21CFR part 177.2470 for the body and 177.2600 for the O-ring.

NSF International Standard 51 and 61.

### Maximum Torque Values for Plastic Threads BSP, BSPT & NPT.

Do not overtighten plastic threaded fittings as this could cause undue stress and eventual failure. Maximum recommended torque figures are shown below.

	Threads		
	1/8" - 1/4"	3/8" - 1/2"	3/4"
<b>Maximum Torque</b>	1.0ft lbs	2ft lbs	3ft lbs
	1.5Nm	3.0Nm	4.0Nm

John Guest recommends that OEM customers consider replacing threaded ports with the more modern Cartridge Systems.

It is recommended that all installations are checked prior to use to determine that a seal has been made.

The maximum torque figures quoted for use with Speedfit fittings are dependent on the mating thread conforming to the relevant U.S., British or International thread standard.

### Maintenance and Replacement Intervals

John Guest products generally require little maintenance but as a minimum we recommend routine visual inspection. Frequency of visual inspection will depend on severity of application and risk of failure. If after visual inspection John Guest products appear damaged, cracked, charred, discolored, heat distorted or corroded, they should be replaced. Any product that is or appears to be leaking should be replaced.

Product life is affected by the severity of the application, the hostility of the working environment and contact with aggressive chemicals or liquids. It is therefore important that specific replacement intervals be considered by specifiers/users/customers based on previous service life or when failure could result in unacceptable downtime, damage or injury risk.

### Cleaners and Sanitizing of Fittings

The external surfaces of John Guest products must not come into contact with oxidizing or acidic cleaners and sanitizing agents, for example (but not limited to) those below pH 4, high in sodium hypochlorite level (bleach) or containing hydrogen peroxide. Our plastic material suppliers recommend ECOLAB Oasis 133 as a suitable cleaner for the external surfaces of products manufactured by John Guest. Several different methods exist for sanitizing the internal surfaces of fluid systems, including sodium hypochlorite, hydrogen peroxide, chlorine dioxide or ozone. It is entirely the responsibility of the end user to determine if the chosen method is suitable for use with John Guest products over the planned working life of the system. However, to avoid unnecessary early failure, John

Guest requires that the disinfection solution must be immediately flushed out at all draw off points with fresh, wholesome water at the end of the disinfection period. The solution must not be left in the system. Disinfection solutions must only come into contact with the internal (fluid carrying) surfaces of the system. If any other surfaces of a fitting come into contact with disinfection solution the whole fitting must be replaced immediately. Polypropylene fittings offer greater resistance to aggressive chemicals but does not have the same mechanical properties as other materials. John Guest polypropylene fittings are generally designated by the part number prefix PP or PPM.

Our material suppliers recommend ECOLAB Oasis 133 as a suitable external cleaner for products manufactured by John Guest.

### Responsibility of Use

While we give a warranty against defects in manufacture or materials, it is the responsibility of the user/installer to ensure that fittings and related products are suitable for their application. The installation must be carried out correctly in accordance with our recommendations, complying with recognized codes of practice and relevant national standards, and be properly maintained. Please refer to our terms and conditions of sale.

### Side Load

Fittings should not be subject to excessive side loads and they should not be used as support brackets. Tubing and fittings should be adequately supported to prevent excessive side loading.

### Product Selection and Installation

John Guest fittings and related products are specifically designed and manufactured by John Guest to the Technical Specifications set out in the John Guest Product Catalog. All John Guest fittings and related products should be selected, installed, used and maintained in accordance with these Technical Specifications. It is the customer's/user's responsibility to ensure that John Guest fittings and related products are suitable for their intended applications, and are properly installed and maintained and are used in accordance with the Technical Specifications. It is also the customer's/user's responsibility to provide its customers with any relevant technical information about John Guest products it supplies them.

The company has a policy of continuous research and development and reserves the right to amend without notice the specification and design of all products illustrated in this catalog. John Guest reserves the right to change the color and shape of products. Photographs are for illustration purposes only.

Subject to our Terms and Conditions of Sale shown on page 83.

**John Guest USA, Inc. is not responsible for misprints or typographical errors.**

## ProLock™ (PSEI and MWI Range) for Products Listed on Pages 62-65.

**Fittings and pipe should be kept clean and undamaged before use.**

### Sizes

3/8" to 1" CTS.

### Pipes

ProLock products can be used with: PEX, Copper and CPVC Pipes conforming to ASTM Standards. ProLock products cannot be used on stainless steel pipe. ProLock stem fittings are only for use with ProLock fittings.

### Standards

ProLock products are designed and manufactured under a fully integrated system assessed by B.S.I. to BS EN ISO9001. ProLock products are also NSF-61, IAPMO and ICC listed.

**Do not use for gas, fuel oil or compressed air applications.**

**Working pressures and temperatures:**

Application	Max. Pressure	Max. Temperature
Water	160 psi	73° F
Water	100 psi	180° F
Water	80 psi	200° F

### Burst Pressure (fittings)

ProLock product used with copper, CPVC or PEX pipe will withstand pressures well in excess of normal service conditions.

### Insulation

Comply with code requirements.

### Minimum bend radius with clips (PEX)

Pipe Diameter	3/8" CTS	1/2" CTS	3/4" CTS	1" CTS
Min Radius	4"	5"	7"	10"

**Clip Spacing (In Inches):** For surface mounted pipes.

Pipe Diameter	Clip Spacing	
	Horizontal Run	Vertical Run
3/8" CTS	12"	20"
1/2" CTS	16"	20"
3/4" CTS	20"	30"
1" CTS	30"	36"

### Expansion (PEX Pipe)

1% on length between 68°F and 180°F.

### Flow rates

Comparable with metal systems.

### Cleaners, inhibitors and descalants

For advice on the use of additives such as corrosion inhibitors, the additive manufacturers should be consulted.

### Paint and Chemicals

Only use water or oil-based paint. **DO NOT ALLOW CONTACT WITH** jointing compounds, cellulose-based paints, paint thinners, paint strippers, solder flux, acid-based descalants or aggressive cleaning products.

### Solder Flux

No fluxes of any type should come into contact with ProLock products. Extreme care should be taken to ensure that no such contact takes place.

### Chlorine

ProLock products are suitable for use with water supplies containing up to 4ppm of chlorine.

### Pipe clips

Pipe clips should not be fitted any closer than 2.5 inches from the end of the fitting. Pipe should be adequately supported by pipe clips to prevent undue stress (side load) on fittings.

### Pipe inserts: Plumbing

John Guest recommends the use of pipe inserts for PEX pipe connections with ProLock product in Standard Residential Plumbing (hot and cold water) installations.

### Pipe inserts: Heating

John Guest requires the use of pipe inserts for PEX pipe connections with ProLock products in all heating installations.

### Connection to boilers

A minimum 36 inches run of copper pipe must be installed between the boiler and the ProLock product system.

### Connection to Hot Water Heater

A minimum 18 inches run of copper pipe must be installed between the hot water heater and the ProLock product system.

### Connection to copper pipe

18 inches is the minimum distance to make a solder connection on copper pipe inserted into a ProLock product. Ensure that no solder flux comes into contact with the fitting.

### Concrete and masonry

Pipe and fittings can be laid in concrete and masonry providing they are installed in conduit pipe with access boxes for the fittings. This is to enable the pipe to expand and provide accessibility for both pipe and fittings. Fittings and pipe should be removable for possible replacement. Insulation is also recommended to protect against heat loss and the effects of frost. Fittings not to be vused underground.

### Electrical continuity

If ProLock products are used in an existing metal system, electrical continuity must be reinstated.

### System testing

To ensure the pipework and fittings have been installed correctly, whether it be on a new or extended system, it is essential that the system be checked and hydraulically wet tested. Testing should be at 30 psi for 10 minutes and 150 psi for 10 minutes. This testing, combined with other relevant checks, should reveal installation problems and is regarded as good plumbing practice. However, system testing should not be regarded as a substitute for correct installation (see also "How to make a ProLock connection").

### Disinfection of Hot and Cold Water Systems

ProLock products can be disinfected after installation or as part of a routine maintenance program. The disinfection procedure must comply with code requirements. Only disinfection solutions specifically recommended as suitable for contact with plastic plumbing systems and, where necessary, employing specialist contractors may be used with ProLock products. Disinfection solutions must only come into contact with the internal (wet) surfaces of the system. If any normal dry surfaces of a ProLock product come into contact with disinfection solution, the whole fitting must be replaced immediately. The disinfection solution must be immediately flushed out at all draw out points with fresh, clean water at the end of the disinfection period. The solution must not be left in the system.

### System flushing

As is usual practice for any plumbing installation, flushing of the system prior to the use of ProLock products is recommended to remove any contaminants/chemical residue from elsewhere in the system.

### Vermin

ProLock products will need protection in vermin-infested areas.

### Tube insertion depths

	3/8" CTS	1/2" CTS	3/4" CTS	1" CTS
<b>PSEI</b>	1 1/8"	1 3/8"	1 1/2"	1 1/2"
<b>MWI</b>	1 1/8"	1 1/8"	1 1/2"	1 1/2"

### Side Loads

Fittings should not be subject to excessive side loads and they should not be used as support brackets. Tubing should be adequately supported to prevent excessive side loading.

**Maximum torque values of threads:** in Ft lbs

	1/2" NPT	3/4" NPT	1" NPT
<b>Plastic</b>	2	3	3
<b>Metal</b>	3	4	4

It is recommended that all installations are checked prior to use to determine that a seal has been made.

**John Guest USA, Inc. is not responsible for misprints or typographical errors.**

## CTS - Twist & Lock™ (PEI and PSEI Range) for Products Listed on Pages 68-73.

**Fittings and pipe should be kept clean and undamaged before use.**

### Sizes

3/8" to 1" CTS.

### Pipes

CTS sized fittings can be used with: PEX, Copper and CPVC Pipes conforming to ASTM Standards. CTS sized fittings cannot be used on stainless steel pipe.

Twist & Lock stem fittings are only for use with Twist & Lock fittings.

### Standards

CTS sized products are designed and manufactured under a fully integrated system assessed by B.S.I. to BS EN ISO9001. CTS sized PEI and PSEI Fittings and CTS sized PEX Pipe are also NSF-14, IAPMO and ICC listed.

**Do not use for gas, fuel oil or compressed air applications.**

### Working pressures and temperatures:

Application	Max. Pressure	Max. Temperature
Water	160 psi	73° F
Water	100 psi	180° F
Water	80 psi	200° F

### Burst Pressure (fittings)

CTS sized fittings used with copper or CTS sized PEX Pipe will withstand pressures well in excess of normal service conditions.

### Insulation

Comply with code requirements.

### Minimum bend radius (PEX)

Pipe Diameter	3/8" CTS	1/2" CTS	3/4" CTS	1" CTS
Min radius	4"	5"	7"	10"

**Clip spacing (in inches):** For surface mounted pipes.

Clip Spacing		
Pipe Diameter	Horizontal Run	Vertical Run
1/2" CTS	16"	20"
3/4" CTS	20"	30"
1" CTS	30"	36"

### Expansion (PEX Pipe)

1% on length between 68°F and 180°F.

### Flow rates

Comparable with metal systems.

### Cleaners, inhibitors and descalants

For advice on the use of additives such as corrosion inhibitors, the additive manufacturers should be consulted.

**Paint and Chemicals:** Only use water or oil based paint. **DO NOT ALLOW CONTACT WITH** jointing compounds, cellulose-based paints, paint thinners, paint strippers, solder flux, acid-based descalants or aggressive cleaning products.

### Solder Flux

No fluxes of any type should come into contact with CTS sized products. Extreme care should be taken to ensure that no such contact takes place.

### Chlorine

CTS sized fittings are suitable for use with water supplies containing up to 4ppm of chlorine.

### Exposure to light

CTS sized products, when used indoors, are not affected by sunlight. When used outdoors, protect from ultraviolet light by lagging or painting.

### Pipe clips

Pipe clips should not be fitted any closer than 2.5 inches from the end of the fitting. Pipe should be adequately supported by pipe clips to prevent undue stress (side load) on fittings.

### Pipe inserts: Plumbing

John Guest recommends the use of pipe inserts for PEX pipe connections with John Guest CTS sized products in Standard Residential Plumbing (hot and cold water) installations.

### Pipe inserts: Heating

John Guest requires the use of pipe inserts for PEX pipe connections with John

Guest CTS sized products in all Heating installations.

### Metal joists

When 'cabling' plastic pipe through metal joists, ensure rubber grommets are in place to prevent damage to the pipe.

### Connection to boilers

A minimum 36 inches run of copper pipe must be installed between the boiler and the CTS sized system.

### Connection to Hot Water Heater

A minimum 18 inches run of copper pipe must be installed between the hot water heater and the CTS sized System.

### Connection to copper pipe

18 inches is the minimum distance to make a solder connection on copper pipe inserted into a CTS sized Fitting. Ensure that no solder flux comes into contact with the fitting.

### Concrete and masonry

CTS sized pipe and fittings can be laid in concrete and masonry providing they are installed in conduit pipe with access boxes for the fittings. This is to enable the pipe to expand and provide accessibility for both pipe and fittings. Fittings and pipe should be removable for possible replacement. Insulation is also recommended to protect against heat loss and the effects of frost. Fittings not to be used underground.

### Electrical continuity

If CTS sized fittings are used in an existing metal system, electrical continuity must be reinstated.

### System testing

To ensure the pipework and fittings have been installed correctly, whether it be on a new or extended system, it is essential that the system be checked and hydraulically wet tested. Testing should be at 30 psi for 10 minutes and 150 psi for 10 minutes. This testing, combined with other relevant checks, should reveal installation problems and is regarded as good plumbing practice. However, system testing should not be regarded as a substitute for correct installation (see also "How to make a Twist & Lock connection").

### Disinfection of Hot and Cold Water Systems

CTS sized fittings can be disinfected after installation or as part of a routine maintenance program. The disinfection procedure must comply with code requirements. Only disinfection solutions specifically recommended as suitable for contact with plastic plumbing systems, where necessary, employing specialist contractors maybe used with CTS sized product. Disinfection solutions must only come into contact with the internal (wet) surfaces of the system. If any normal dry surfaces of a CTS sized product come into contact with disinfection solution, the whole fitting must be replaced immediately. The disinfection solution must be immediately flushed out at all draw out points with fresh, clean water at the end of the disinfection period. The solution must not be left in the system.

### System flushing

As is usual practice for any plumbing installation, flushing of the system prior to the use of CTS sized fittings is recommended to remove any contaminants/chemical residue from elsewhere in the system.

### Vermin

CTS sized products will need special protection in vermin infested areas.

### Tube insertion depths

	3/8" CTS	1/2" CTS	3/4" CTS	1" CTS
PEI	N/A	1 1/4"	1 5/8"	1 5/8"
PSEI/MWI	1 1/16"	1 1/8"	1 1/2"	1 1/2"

### Side Loads

Fittings should not be subject to excessive side loads and they should not be used as support brackets. Tubing should be adequately supported to prevent excessive side loading.

### Maximum torque values of threads: in Ft lbs

		1/2" NPT	3/4" NPT	1" NPT
Plastic	NPT	2	3	3
Metal	NPT	3	4	4

It is recommended that all installations are checked prior to use to determine that a seal has been made.

**John Guest USA, Inc. is not responsible for misprints or typographical errors.**

# Terms and Conditions

The products described in this document are hereby offered for sale to be established by John Guest (USA) Inc., its subsidiaries and its authorized distributors. This offer and its acceptance by any customer (the "Buyer") shall be governed by all of the following Terms and Conditions. Buyer's order for any item described in this document, when communicated to John Guest (USA) Inc., its subsidiaries or an authorized distributor (the "Seller") verbally or in writing, shall constitute acceptance of this offer.

1. **Terms and Conditions of Sale.** All descriptions, quotations, proposals, offers, acknowledgments, acceptances and sales of the Seller's products are subject to and shall be governed exclusively by the terms and conditions stated herein (the "Agreement"). The Buyer's acceptance of any offer to sell is limited to the terms and conditions in the Agreement. Any terms or conditions in addition to, or inconsistent with those stated in the Agreement, proposed by the Buyer in any acceptance of an offer by the Seller, are hereby objected to. No such additional, different or inconsistent terms and conditions shall become part of the agreement between the Buyer and the Seller unless expressly accepted in writing by the Seller. The Seller's acceptance of any offer to purchase by the Buyer is expressly conditioned upon the Buyer's assent to all the terms and conditions in this Agreement, irrespective of any terms in addition to, or inconsistent with those contained in the Buyer's offer. Acceptance of the Seller's products shall in all events constitute such assent.

2. **Documents.** Unless provided otherwise in the Agreement, all catalog descriptions, illustrations, drawings and literature or independently submitted estimates of performance, weights and measurements or other specifications provided by the Seller are mere approximations and the Seller reserves the right to alter or amend the same at any time. The Seller reserves the right to correct clerical or technical errors in the contract documents. The Buyer shall furnish with his order all necessary specifications and information. The Seller takes no responsibility for goods manufactured, priced or delivered not in accordance with the order or the specifications unless the Buyer's order and specifications are clear and correct.

3. **Prices.** Unless otherwise provided, all prices contained in our quotations and written acceptances are ex works and do not include the cost of packing. All orders are accepted on the condition that all such prices are subject to revision by the Seller at any time before the goods are dispatched to take account of any price change. In the event that the Buyer does not place the entire order quoted by the Seller for the Buyer, the Seller reserves the right to revise its prices. The Seller also reserves the right to revise its prices if the Buyer modifies the specification or quantity of the goods, or the delivery requirements after the order has been accepted by the Seller.

4. **Advice.** All advice given in connection with the Seller's goods is provided without charge to the Buyer. Any advice and assistance given by the Seller to the Buyer is given at the Buyer's risk and the Seller shall not be liable for any loss, damage or claim arising therefrom.

5. **Payment.** (a) Unless otherwise provided in the Agreement, or explicitly agreed upon in writing by the Seller, payment is due in full 30 days from date of shipment of the items purchased hereunder. (b) In the case of an installment contract, deliveries or parts, payment for each installment delivery or part shall be made under sub-clause (a) as if the same constituted a separate agreement. (c) Amounts not timely paid shall bear interest at the rate of 2-1/2% above the Seller's bank's prime rate from time to time in force. (d) A bank fee shall apply to all payments received via wire transfer. (e) Payments made with a credit card shall incur a 2% bank fee. (f) In the event that the Buyer fails within one calendar month of the date for payment to effect any payment which may be due under the Agreement or any agreement with the Seller, or if the Buyer commits any breach of the Agreement, or if the Buyer becomes insolvent or commits any act of bankruptcy or contemplation of liquidation, the Seller will be entitled, without prejudice to the Seller's other rights, to terminate the Agreement or any unfulfilled part thereof, or at the Seller's option to make partial deliveries.

6. **Modifications and Cancellations.** This Agreement is not subject to oral modification or cancellation. A Buyer's request for modification or cancellation will not be incorporated into the Agreement unless the request is accepted by the Seller in a writing that amends the Agreement. Acceptance of any such requested modification or cancellation shall be at the Seller's discretion and shall be upon such terms and conditions as the Seller may require.

7. **Handling Charge.** Goods supplied in accordance with the Buyer's order may later be returned to the Seller at the Seller's discretion provided the return is pre-authorized, in writing and the merchandise is unused, in original packages, unaltered, clean and no older than 60 days from the date of shipment by the Seller. The Buyer shall pay to the Seller a handling charge of 25% of the purchase price of the returned goods. A copy of the original invoice for the merchandise must accompany all returns.

8. **Delivery.** (a) Any delivery dates quoted are approximate only and the Seller shall have no liability for any delays in delivery. (b) Unless provided otherwise, delivery of the goods shall be made when the Seller has notified the Buyer that the goods are ready for dispatch. Regardless of the method of delivery, delivery shall be made F.O.B. Seller's plant, where the risk of loss shall thereupon pass to the Buyer upon the Seller's delivery to a carrier. Notwithstanding that the Seller's prices are ex-works, the Seller is prepared by special contract to procure carriage or freight and insurance on behalf of the Buyer and at Buyer's cost in which event the Seller shall be under no liability for damage in transit or loss or damage to the goods beyond the point at which the Seller contracts to deliver the same. (c) Seller will not make drop shipments.

9. **Inspection and Rejection.** (a) The following provisions shall apply in relation to all deliveries of goods: the Seller shall not be held liable for any claims of damage in transit, shortage of delivery or loss of goods, unless in the case of shortage of delivery, a separate notice in writing is given to the carrier concerned and to the Seller within three (3) days of the receipt of the goods, followed by a complete claim in writing within five (5) days of receipt of the goods and in the case of loss of goods, a separate notice in writing is given to the carrier concerned and to the Seller and a complete claim in writing made within thirty (30) days of the date of consignment. The Buyer must inspect the goods on arrival from the carrier, however, where goods are accepted from the carrier concerned without being inspected, the delivery book of the carrier concerned must be signed "not examined". The Seller shall have the right to inspect the goods at the Buyer's premises in respect to any such claims made by the Buyer and the Buyer shall retain such goods until the Seller has inspected such goods or until the Seller has notified the Buyer that the Seller does not wish to inspect such goods. Any breach of these conditions in this provision shall serve as a waiver to any claim brought by the buyer. (b) Without prejudice to the Seller's other rights, should the Buyer fail for any reason to send the Seller forwarding instructions within ninety (90) days after the date of the Seller's notification that the goods are ready for dispatch or to accept delivery of the goods, the Seller shall be entitled at the Buyer's risk and expense to store the goods and/or to procure or effect storage of the goods elsewhere. Goods so stored shall be paid for as if they had been dispatched and/or accepted.

10. **Special Tooling.** Where it is necessary for the Seller to manufacture or to purchase special tooling, including without limitation tools, dies, jigs, mandrills, fixtures, molds, and patterns in order to execute a contract, the Buyer will be charged with a proportion of the cost of such special tools. Such special tooling shall be and remain the Seller's property notwithstanding payment of any charges made by the Buyer. In no event will the Buyer acquire any interest in apparatus belonging to the Seller which is utilized in the manufacture of the items sold hereunder, even if such apparatus has been specially converted or adopted for such manufacture and notwithstanding any charges paid by the Buyer therefor. Unless otherwise agreed, the Seller shall have the right to alter, discard or otherwise dispose of any special tooling or other property in its sole discretion at any time.

11. **Test and Performance.** (a) The Seller's goods are, where practicable, submitted to the Seller's standard test before delivery. If special tests are required, these shall be made at the Seller's premises unless otherwise agreed, and will be subject to an extra charge. (b) The Seller accepts no liability for failure to attain any performance figures quoted by the Seller unless the Seller specifically has guaranteed them with an agreed sum as liquidation damages and the Buyer has suffered actual loss by reason of the failure to attain the figures quoted. (c) Any particulars of weights and measurements, power and consumption, power output or performance relating to the goods and like matters furnished by the Seller to the Buyer in the Seller's catalogs, literature or otherwise, are approximate and are intended only to present a general idea of the goods to be supplied and unless previously agreed specifically in writing shall not form part of the Agreement.

12. **Buyer's Property.** Any designs, tools, patterns, materials, drawings, confidential information or equipment furnished to the Seller by the Buyer, or any other items which become the Buyer's property, may be considered obsolete and may be destroyed by the Seller after two (2) consecutive years have elapsed without the Buyer placing an order for the items which are manufactured using such property. The Seller shall not be responsible

for any loss or damage to such property while it is in the Seller's possession or control.

13. **Taxes.** Unless otherwise indicated, all prices and charges are exclusive of excise, sales, use, property, occupational or like taxes which may be imposed by any taxing authority upon the manufacture, sale or delivery of the items sold hereunder. If any such taxes must be paid by the Seller, or if the Seller is liable for the collection of such tax, the amount thereof shall be in addition to the amounts for the item sold. The Buyer agrees to pay all such taxes or to reimburse the Seller therefor upon receipt of its invoice. If the Buyer claims exemption from any sales, use or other tax imposed by any taxing authority, the Buyer shall promptly indemnify and hold the Seller harmless from and against any such tax, as well as any interest or penalties thereon which may be assessed if the items are held to be taxable.

14. **Warranty.** (a) The Seller warrants that the items sold hereunder shall be free from defects in material or workmanship at the time of shipment by the Seller. The Seller warrants that if within 12 months of delivery of the goods to the Buyer the Buyer returns immediately to the Seller's premises any of the said goods which the Buyer believes to be defective, carrier paid, properly packed and clearly marked with the Buyer's full name and address and any other information such as serial numbers which may be necessary to enable the goods to be identified, together with a complete description of the respects in which it is alleged that the goods are defective, they will be repaired or new goods will be supplied in exchange and the goods so repaired or such new goods will be delivered to the Buyer free of charge at the Seller's premises provided that the foregoing warranty shall only be applicable if upon demand by the Seller, the Buyer promises to the Seller's satisfaction: (i) that the defect was due solely to defective workmanship; (ii) that no alterations or repairs have been made to the goods except with the Seller's written consent; (iii) that the defect was not caused by any act of the Buyer or its agents; and (iv) that the defect was not caused by any matter beyond the reasonable control of the Seller, including, without limitation, accident or normal wear and tear. (b) For John Guest PEI, MWI and PSEI Series Plumbing products and Speedfit PEX Pipe only, the warranty period contained in sub-paragraph (a) may be extended to 300 months (25 years) from date of delivery of the goods to the Buyer provided that, in addition to all other requirements, Seller's products are: (i) used in domestic plumbing applications; (ii) installed by a Licensed Contractor, Plumber or qualified equipment installation professional; and (iii) installed and operated in accordance with published John Guest technical specifications. (c) All costs and expenses, including freight charges, customs duties, and insurance incurred in returning the goods to the Seller's premises in accordance with this provision shall be paid by the Buyer. The benefit of this warranty shall not be assignable by the Buyer. (d) The warranty contained in sub-paragraphs (a) and (b) above does not extend to any goods not manufactured by the Seller even though supplied by the Seller nor does it extend to any second-hand or reconditioned goods nor does it extend to components manufactured by the Seller but installed, attached or welded by the Buyer or his customer on equipment not manufactured by the Seller. Goods not manufactured by the Seller carry only the warranty (if any) of their makers and the Buyer is entitled to the benefit thereof only so far as the Seller has the power to transfer it. (e) This warranty comprises the sole and entire warranty pertaining to items provided hereunder; the Seller makes no other warranty, guarantee, or representation of any kind whatsoever. All other warranties, including but not limited to, merchantability and fitness for purpose, whether expressed or implied, or arising by operation of law, trade usage, or course of dealing are hereby disclaimed. (f) Notwithstanding the foregoing, there are no warranties whatsoever on items built or acquired wholly or partially to the Buyer's designs or specifications.

15. **Limited Remedy.** The Seller's liability arising from or in any way connected with the items sold or this Agreement shall be limited exclusively to repair or replacement of the items sold. In no event shall the Seller be liable to the Buyer or any 3rd party for any incidental, consequential or special damages of any kind or nature whatsoever, including but not limited to lost profits arising from or in any way connected with this agreement or items sold hereunder, whether alleged to arise from breach of contract, express or implied warranty, or in tort, including without limitation, negligence, failure to warn or strict liability.

16. **Indemnity for Infringement of Intellectual Property Rights.** (a) The Buyer shall defend and indemnify the Seller against all actions, claims, demands, penalties and costs by 3rd parties in tort, or for infringement, or alleged infringement, of patents, trademarks, copyrights, trade dress, trade secret or other rights of any 3rd party resulting from the goods manufactured in accordance with the Buyer's specifications or based on any information provided by the Buyer. The Buyer will defend any action against the Seller for title, patent, trademark, copyright infringement, or other claimed by a 3rd party at the Buyer's sole cost and expense. (b) The Seller shall have no liability for infringement of any patents, trademarks, copyrights, trade dress, trade secrets or similar rights except as provided in this provision. The Seller will defend and indemnify the Buyer against allegations of infringement of US patents, US trademarks, copyrights, trade dress and trade secrets ("Intellectual Property Rights"). The Seller will defend at its expense and will pay the cost of any settlement or damages awarded in an action brought against the Buyer based on an allegation that an item sold pursuant to this contract infringes the Intellectual Property Rights of a 3rd party. The Seller's obligation to defend and indemnify the Buyer is contingent on the Buyer notifying the Seller within 10 days after sole control over the defense of any allegations or actions, including all negotiations for settlement or compromise. If an item sold hereunder is subject to a claim that it infringes the Intellectual Property Rights of a 3rd party, the Seller may, at its sole expense and option, procure for the Buyer the right to continue using said item, replace or modify said item so as to make it non-infringing, or offer to accept return of said item and return the purchase price less a reasonable allowance for depreciation. Notwithstanding the foregoing, the Seller shall have no liability for claims of infringement based on information provided by Buyer, or directed to items delivered hereunder for which the designs are specified in combination or use in a system of any item sold hereunder. The foregoing in this provision shall constitute the Seller's sole and exclusive liability and the Buyer's sole and exclusive remedy for infringement of Intellectual Property Rights.

17. **Lien.** In addition to any right of lien to which the Seller may by law be entitled, the Seller shall have a general lien on all goods of the Buyer in the Seller's possession (although such goods or some of them may have been paid for) for the unpaid price of any other goods sold and delivered to the Buyer by the Seller under the same or other contracts.

18. **Waiver.** The Seller's rights shall not be affected or restricted by any indulgence or forbearance granted to the Buyer. No waiver by the Seller of any breach shall operate as a waiver of any later breach.

19. **Force Majeure.** The Seller shall be excused from performing any of its obligations under this Agreement which are prevented or delayed by any occurrence not within the reasonable control of the Seller, including but not limited to, accidents, acts of God, destruction or damage to the goods or the Seller's manufacturing plant, delays or failures in delivery of carriers or suppliers, shortages of materials, strikes or other labor matters, floods, earthquakes, fire, riots, explosions, or any regulations, rules, ordinances or orders of any governmental authority, federal, state or local, whether such cause exists at the date of the order or not.

20. **Buyer's Representation of Solvency.** The Buyer hereby represents that as of the signing of this Agreement it was not insolvent within the meaning of the Uniform Commercial Code or the Bankruptcy Laws of the United States.

21. **Assignment and Delegation.** The rights and obligations of the parties under this Agreement may not be assigned or delegated, except on the express written consent of the other party to the assignment or delegation.

22. **Integration.** The rights and obligations of the parties and the terms and conditions set forth herein, together with any amendments, modifications and any different terms and conditions expressly accepted by the Seller in writing, shall constitute a complete and exclusive statement of the terms of this Agreement. This Agreement supersedes not only all prior agreements, but also oral agreements made contemporaneously with the execution of this Agreement. All such materials may not be used to supplement, explain, or contradict the terms of this Agreement.

23. **Severability.** If any of these conditions or any part thereof purports to exclude or restrict or limit any liability and such exclusion or restriction or limitation is prohibited or rendered void or unenforceable by any legislation to which it is subject, or is itself prohibited or rendered void or unenforceable by any legislation to which it is subject, then the exclusion restriction or limitation on the condition or part thereof in question shall be so prohibited or rendered void or unenforceable and the validity or enforceability of any other part of these provisions shall not thereby be affected.

24. **Governing Law/Limitation on Actions.** The terms, conditions, rights, and obligations under this Agreement shall be construed under the laws of the State of New York, without regard to principles of conflicts of laws. No actions arising out of the sale of the items sold hereunder or this Agreement may be brought by the Buyer more than two (2) years after such cause of action accrues.

# Limited Warranty

## SharkBite™, Cash Acme™, HoldRite™, John Guest™ Products

### What does this warranty cover?

Subject to conditions outlined in this statement, RWC (in the USA, Reliance Worldwide Corporation and in Canada, Reliance Worldwide Corporation (Canada) Inc.) warrants to owners of real property in the United States and Canada that SharkBite and Cash Acme products, when used and installed in accordance with the requirements set forth, shall be free from defects in material and workmanship for the applicable Warranty Period. This Limited Warranty is in effect for installations made after January 1, 2018 and is applicable to products installed in the country in which they were purchased.

Proof of purchase is required to validate the Warranty Period. If proof of purchase is not available, the Warranty Period commencement shall default to the date of manufacture for each product. If the product suspected of a defect does not have a clear date of manufacture on it, a proof of purchase will be required.

### What are the conditions of this warranty?

1. All products must be installed in accordance with all then applicable codes, good plumbing practice, in accordance with any local, state, provincial or federal requirements, and installed in a potable water or radiant heating application unless a non-potable water service is specifically allowed for in the pertinent product literature.
2. The installer must use construction techniques compliant with then applicable codes to install the product and use the product within the design parameters specified in any installation guidelines and technical notes for the applicable system. This shall include field pressure testing prior to concealing with concrete or by other means and wrapping any brass fitting when buried. Failure to install RWC products according to manufacturer's installation instruction will void all applicable warranties and may result in severe water damage.
3. Products must at all times be used in a manner consistent with their intended use and be used in installations and environments acceptable to their material and design specifications, including not being installed in a system that may operate at temperatures or at pressures that exceed the approved ratings which can be found on the product, packaging or installation instructions.
4. Additional product specific conditions of this Limited Warranty and the Warranty Period are documented in the section entitled "HOW LONG DOES THE LIMITED WARRANTY COVERAGE LAST AND WHAT OTHER SPECIFIC CONDITIONS EXIST FOR EACH PRODUCT?".
5. Without limiting the foregoing, this Limited Warranty does not apply and you do not have a right of reimbursement if the product failure or resulting damage is caused by: (a) evidence of tampering, mishandling, neglect, abuse, accidental damage, freeze damage (it is expressly understood that failure as a result of any freezing fluids within the pipes does not constitute a defect in material or workmanship and shall not be covered by this warranty) or unauthorized modifications or repairs that cause damage to warranted products; (b) exposure to harmful, unauthorized, or unanticipated chemicals or substances or corrosive water conditions; (c) exposure to ultraviolet light; (d) faulty installation including failure to follow proper burial instructions; (e) damage from abnormal operating conditions including exposure pressures and temperatures beyond the specified operating range; (f) failure to properly test and pass common testing methods (including pressure testing) after the installation and before the product or system is put in service; (g) components not manufactured or sold by RWC; or (h) acts of nature such as earthquakes, fire, flood or lightning.
6. Although RWC provides a plumbing system to facilitate a complete installation, other manufacturers pipe and/or fittings may be installed in any given installation provided manufacturing of the pipe and/or fittings demonstrates compliance with the applicable ASTM/CSA standards, and the product has been certified by a recognized third-party testing agency. The RWC product in the given installation will continue to be covered under this Limited Warranty although limits on Warranty Period may apply. RWC will be responsible only for proven defects in material or workmanship in RWC products. Problems in products manufactured by another company should be reported to that manufacturer.

### How do you get service?

In order to be eligible for service under this Limited Warranty you must return the defective product to RWC for inspection and testing within thirty (30) days after detection of alleged failure or defect occurring within applicable Warranty Period (with shipping charges prepaid) to the original place of purchase. If the alleged defect involves a connection or joint with a RWC product, the fitting must be returned with a section of the pipe still inserted. You must include the model number of the product (if available), the original date of purchase, proof of purchase and the nature of the alleged product failure or defect. Products returned without shipping charges prepaid will be refused. For questions or inquiries, in the U.S. call 1(877)700-4242 and in Canada 1(888)820-0120.

### What will RWC do?

If, after inspection, we find that a product covered by this Limited Warranty has failed due to a defect in material or workmanship during the specified Warranty Period, we will repair or replace, at our sole option, free of charge, the defective product during normal working hours and through a place of business as determined by RWC.

Notwithstanding anything to the contrary in this Limited Warranty, if RWC determines that any damages to the real property in which a defective product was installed were the direct result of a leak or failure caused by a defect in material or workmanship in any RWC product covered by this Limited Warranty and occurring within the first ten years after date of purchase or during the applicable Warranty Period, whichever is shorter, and if reasonable steps were taken to promptly limit or stop the effects of such leak or failure as soon as it was discovered, then RWC will reimburse the property owner for the reasonable costs of repairing or replacing such damaged real property to include flooring, drywall and painting and other real property damaged by the leak directly caused by the allegedly defective RWC product when the RWC SharkBite Connection System product was installed by a licensed professional plumbing contractor. Except as specified above or otherwise specifically authorized in writing by RWC, RWC shall not pay for any costs or expenses for transportation, relocation, labor, repairs or any other work associated with removing and/or returning failed or defective products or installing replacement products.

This shall constitute the sole and exclusive remedy for any defective product.

### What does this limited warranty not cover?

RWC shall not be responsible for any other incidental, indirect, contingent, special or consequential damages, including without limitation, economic loss, lost profits or the cost of repairing or replacing other property which is damaged if these warranted products do not work properly, other costs resulting from labor charges, delays, vandalism, negligence, fouling caused by foreign material, damage from adverse water conditions, adverse chemical environments, or

any other circumstances over which RWC has no control. This limitation applies even if RWC could have foreseen or has been advised of the possibility of these damages. This Limited Warranty shall be invalidated by any abuse, misuse, misapplication or improper installation of the product. Any remaining warranty coverage may not be assigned or transferred after the period ending ten years following the installation. RWC does not guarantee or in any way warrant the integrity or workmanship of the contractor/installer.

### Miscellaneous

Some States/Provinces do not allow limitations on how long an implied warranty lasts, and some States/Provinces do not allow the exclusion or limitation of incidental or consequential damages. Therefore, the above limitations may not apply to you. This Limited Warranty gives you specific legal rights, and you may have other rights that vary from State/Province to State/Province. You should consult applicable State/Provincial laws to determine your rights.

SO FAR AS IS CONSISTENT WITH APPLICABLE STATE/PROVINCIAL/FEDERAL LAW, THE EXPRESS WARRANTY SET FORTH HEREIN IS THE ONLY WARRANTY GIVEN BY RWC WITH RESPECT TO THE SHARKBITE™ AND CASH ACME™ PRODUCTS AND RWC MAKES NO OTHER WARRANTIES, EXPRESSED OR IMPLIED, AND HEREBY SPECIFICALLY DISCLAIMS ALL OTHER WARRANTIES, EXPRESSED OR IMPLIED, INCLUDING BUT NOT LIMITED TO THE IMPLIED WARRANTIES OF MERCHANTABILITY AND FITNESS FOR A PARTICULAR PURPOSE.

This Limited Warranty and any claims arising from breach of contract, breach of warranty, tort, or any other claim arising from sale or use of RWC's products shall be governed and construed under the laws of the State of Georgia. No action on the part of RWC under this Limited Warranty shall be construed as an admission of liability of that the product is not fit for its intended use.



## How long does the limited warranty coverage last and what other specific conditions exist for each product?

Classification	Product Category	Limited Warranty Period	Conditions
<b>SharkBite Connection Systems</b>	SharkBite Brass and Poly PEX Barb Fittings in conjunction with SharkBite PEX Pipe and SharkBite Rings/Clamps	Twenty-Five (25) Years	Must be used with <ul style="list-style-type: none"> <li>SharkBite PEX Pipe - ASTM F876/CSA B137.5</li> <li>SharkBite Copper Crimp Rings - ASTM F1807 or F2159</li> <li>SharkBite Stainless Steel Clamp Rings - ASTM</li> </ul>
	SharkBite EvoPEX Fittings in conjunction with SharkBite PEX Pipe	Twenty-Five (25) Years	Must be used with SharkBite PEX Pipe - ASTM F876/CSA B137.5
	SharkBite Universal Push-To-Connect Fittings in conjunction with SharkBite PEX Pipe	Twenty-Five (25) Years	Must be used with SharkBite PEX Pipe - ASTM F876/CSA B137.5
<b>SharkBite, Cash Acme, HoldRite, and John Guest Products</b>	SharkBite Universal Push-To-Connect Fittings in Application with Copper, PEX, CPVC and/or PE-RT	Twenty-Five (25) Years	Must be used with: <ul style="list-style-type: none"> <li>Copper-ASTM B 88 hard drawn copper tube K, L, and M</li> <li>PEX-ASTM F876/CSA B137.5</li> <li>CPVC-ASTM D2846 or CSA B137.6</li> </ul>
	SharkBite Universal Push-To-Connect Fittings in Application with HDPE	Five (5) Years	Must be used with HDPE SDR-9 ASTM D2737
	SharkBite Accessories (Ball Valves, Supply Hoses, Supply Stops, Supply Valve Box Systems, Kits, Copper Manifolds, etc.)	Two (2) Years	Must be installed per installation instructions with the pipes below: <ul style="list-style-type: none"> <li>Copper-ASTM B 88 hard drawn copper tube K, L, and M</li> <li>PEX-ASTM F876/CSA B137.5</li> <li>CPVC-ASTM D2846 or CSA B137.6</li> <li>PE-RT-ASTM F2769</li> </ul>
	SharkBite ProLock	Twenty-Five (25) Years	Must be used with: <ul style="list-style-type: none"> <li>SharkBite PEX - ASTM F876/CSA B137.5</li> <li>SharkBite PE-RT - ASTM F2769</li> <li>Copper-ASTM B 88 hard drawn copper tube K, L, and M</li> <li>CPVC-ASTM D2846 or CSA B137.6</li> </ul>
	SharkBite Poly PEX Barb Fittings	Five (5) Years	When used with Non-SharkBite PEX Pipe that conform to ASTM F876 CSA B137.5, PE-RT that conform ASTM F2769, and Clamp/Rings ASTM F2159
	SharkBite Brass PEX Barb Fittings/ Copper Manifold	Five (5) Years	When used with Non-SharkBite PEX Pipe that conform to ASTM F876/CSA B137.5, that conform ASTM F2769 and Clamp/Rings - ASTM F1807
	SharkBite EvoPEX Fittings	Five (5) Years	When used on Non-SharkBite PEX Pipe that conform to ASTM F876/CSA B137.5
	SharkBite PEX Pipe	Twenty-Five (25) Years	When used with Fitting and Clamps/Rings that conform to ASSE 1061, ASTM F1807, ASTM F2098, and/or ASTM F2159 Fittings
	SharkBite PE-RT Pipe	Twenty-Five (25) Years	When used with Fitting and Clamps/Rings that conform to ASSE 1061, ASTM F1807, ASTM F2098, and/or ASTM F2159 Fittings
	SharkBite Home Run Manifolds	Ten (10) Years	Must be installed per installation instructions
	SharkBite Tools	One (1) Year	From date of purchase
	SharkBite and Cash Acme Thermostatic Mixing Valves	Five (5) Years	Must be installed per installation instructions
	Other SharkBite and Cash Acme Valves	Two (2) Years	Must be installed per installation instructions
	John Guest Black ProLock CTS Fittings	Twenty-Five (25) Years	Must be used with: <ul style="list-style-type: none"> <li>PE-RT - ASTM F2769</li> <li>Copper-ASTM B 88 hard drawn copper tube K, L, and M</li> <li>PEX-ASTM F876/CSA B137.5</li> <li>CPVC-ASTM D2846 or CSA B137.6</li> </ul>
	John Guest Speedfit Twist & Lock CTS Fittings	Twenty-Five (25) Years	Must be used with: <ul style="list-style-type: none"> <li>Copper-ASTM B 88 hard drawn copper tube K, L, and M</li> <li>PEX-ASTM F876/CSA B137.5</li> <li>CPVC-ASTM D2846 or CSA B137.6</li> </ul>
	John Guest Fluid System OD Fittings	One (1) Years	Must be used with Polyethylene, Nylon, PEX, or Soft Copper (must be round and in good condition)
	John Guest LLDPE Tubing	One (1) Years	Must be installed per installation instructions
	SharkBite Quick-Connect POM Plastic Fittings	One (1) Years	Must be used with Polyethylene, Nylon, PEX, or Soft Copper (must be round and in good condition)
	HoldRite Products	One (1) Years	Must be installed per installation instructions
	HoldRite QuickBrand Products	One (1) Years	Must be installed per installation instructions
HoldRite Testrite	One (1) Years	Must be installed per installation instructions	
HoldRite HydroFlame Pro	Two (2) Years	Must be installed per installation instructions	







For more information and to find  
your nearest distributor, visit  
[johnguest.com](http://johnguest.com)

Connect with us



Manufactured & Distributed by Reliance Worldwide Corporation.  
JG-CAT-Fluid System-1467396991-0225

